

670-
c2

S/S May 69

UNIFORM AND INSIGNIA

MALE PERSONNEL



RETURN TO ARMY LIBRARY
ROOM 1 A 518 PENTAGON

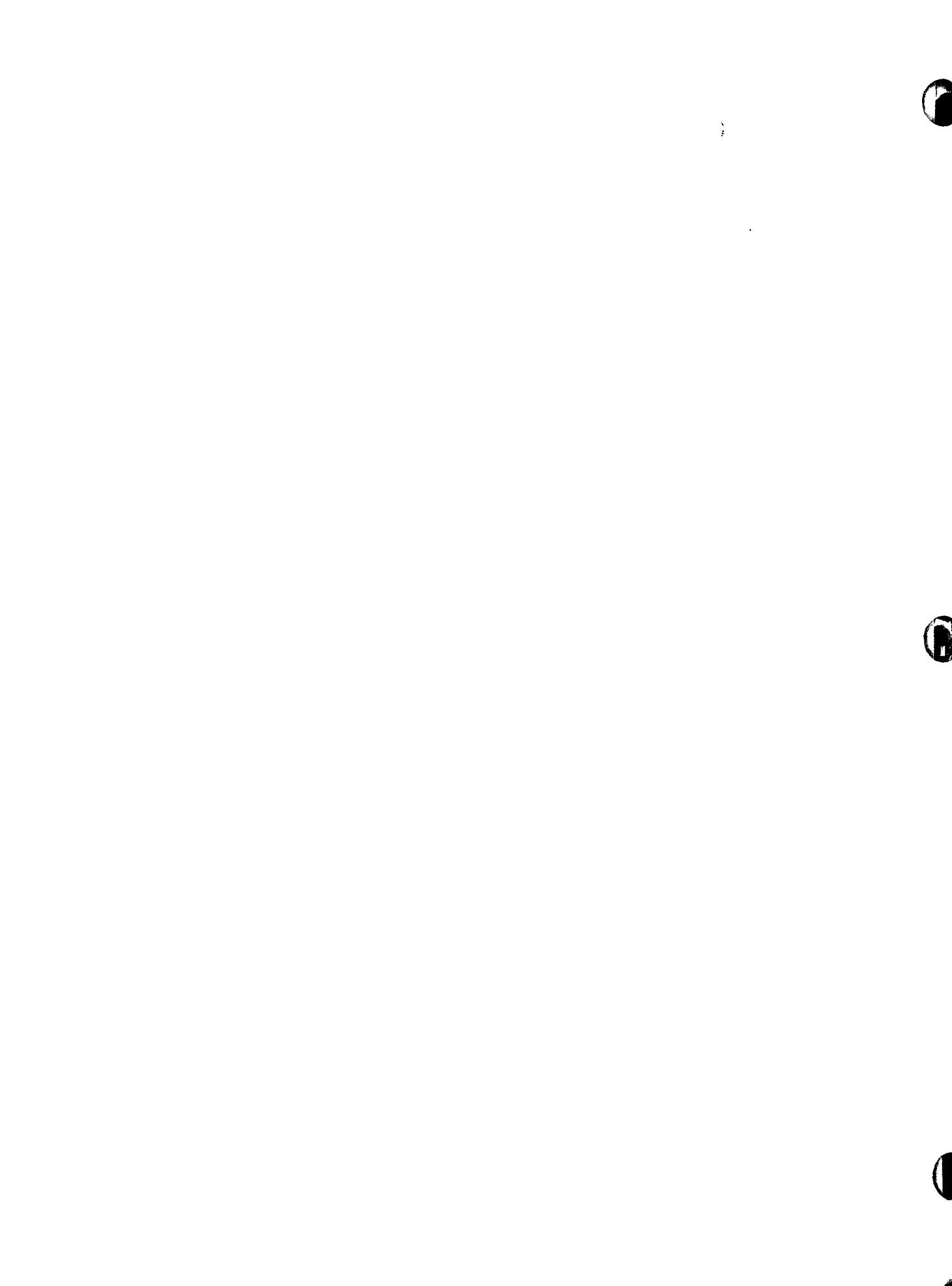

UNIFORM AND INSIGNIA

MALE PERSONNEL

CHAPTER	1. GENERAL	Paragraph	Page
	Purpose.....	1-1	1-1
	Wearing of uniform.....	1-2	1-1
	Wearing of civilian clothing.....	1-3	1-1
	Uniformity of material.....	1-4	1-1
	Wearing of civilian decorations and jewelry.....	1-5	1-1
	Wearing of identification tags, security identification badges, nameplates, and nametapes.....	1-6	1-1
	Distinctive uniforms and articles thereof.....	1-7	1-2
	Wearing of headgear.....	1-8	1-2
	Color of ornamentation and insignia for detailed officers.....	1-9	1-3
	Of adopted design.....	1-10	1-3
	2. RESPONSIBILITIES		
	Individual purchase of uniforms from commercial or exchange sources.....	2-1	2-1
	Purchase of uniform items.....	2-2	2-1
	Officers and warrant officers.....	2-3	2-1
	Enlisted men.....	2-4	2-1
	Commanders.....	2-5	2-1
	3. WEAR OF UNIFORM BY RESERVE COMPONENTS, RETIRED, SEPARATED, AND CIVILIAN PERSONNEL		
	Occasions of ceremony.....	3-1	3-1
	Army National Guard and Army Reserve.....	3-2	3-1
	Retired officers, warrant officers, and enlisted men.....	3-3	3-2
	Former members of the Armed Forces.....	3-4	3-2
	For members of the Armed Forces.....	3-5	3-3
	Civilians.....	3-6	3-3
	Requirement for distinctive insignia.....	3-7	3-3
	Retirement ceremonies.....	3-8	3-4
	4. FIELD AND WORK UNIFORMS		
	Composition.....	4-1	4-1
	Additional articles for military police.....	4-2	4-1
	Boots, service, combat, black.....	4-3	4-1
	Chaplains' apparel.....	4-4	4-1
	Shirt and trousers, olive green, Army shade 108.....	4-5	4-1
	Coats, shirts, and trousers, olive green.....	4-6	4-1
	Cap, utility, olive green, Army shade 106.....	4-7	4-2
	Ornamentation.....	4-8	4-2
	5. ARMY KHAKI UNIFORM		
	Authorization for wear.....	5-1	5-1
	Composition.....	5-2	5-1
	Occasions for wear.....	5-3	5-1
	Materials.....	5-4	5-1
	Trousers.....	5-5	5-1
	Shirt, short sleeve.....	5-6	5-1
	Shorts, cotton, khaki.....	5-7	5-1
	Headgear.....	5-8	5-1
	Socks.....	5-9	5-1

*This regulation supersedes AR 670-5, 23 September 1966, and Change thereto; so much of DA message 816866, 29 May 1967, as pertains to AR 670-5; and DA message 819894, 19 June 1967.

CHAPTER 6. ARMY TAN UNIFORM

	Paragraph	Page
Authorization for wear	6-1	6-1
Composition	6-2	6-1
Occasions for wear	6-3	6-1
Materials—coat, trousers, and shirt (outer garment), shade M-1 or Army shade 61	6-4	6-1
Coat	6-5	6-1
Trousers, design	6-6	6-1
Shirt (outer garment) short sleeve	6-7	6-1
Headgear	6-8	6-1
7. ARMY GREEN UNIFORM		
Authorization for wear	7-1	7-1
Composition	7-2	7-1
Occasions for wear	7-3	7-1
Materials	7-4	7-1
Coat	7-5	7-1
Trousers	7-6	7-1
Headgear, cap	7-7	7-1
8. ARMY WHITE UNIFORM		
Authorization for wear	8-1	8-1
Composition	8-2	8-1
Occasions for wear	8-3	8-1
Materials—coat, trousers, and headgear, cap, white	8-4	8-1
Coat	8-5	8-1
Trousers, design	8-6	8-1
Headgear, cap	8-7	8-1
Insignia	8-8	8-2
9. ARMY BLUE UNIFORM		
Authorization for wear	9-1	9-1
Composition	9-2	9-1
Occasions for wear	9-3	9-1
Materials	9-4	9-1
Coat	9-5	9-1
Trousers	9-6	9-3
Headgear, cap	9-7	9-3
Insignia	9-8	9-4
10. ARMY WHITE MESS UNIFORM		
Authorization for wear	10-1	10-1
Composition	10-2	10-1
Occasions for wear	10-3	10-1
Materials	10-4	10-1
Jacket	10-5	10-1
Trousers, design	10-6	10-2
Vest	10-7	10-2
Headgear	10-8	10-2
Insignia	10-9	10-2
11. ARMY BLUE MESS UNIFORM		
Authorization for wear	11-1	11-1
Composition	11-2	11-1
Occasions for wear	11-3	11-1
Materials	11-4	11-1
Jacket	11-5	11-1
Trousers	11-6	11-2
Vest	11-7	11-2
Headgear	11-8	11-2
Insignia	11-9	11-2

CHAPTER 12. ARMY EVENING DRESS UNIFORM

	Paragraph	Page
Authorization for wear.....	12-1	12-1
Composition.....	12-2	12-1
Occasions for wear.....	12-3	12-1
Materials.....	12-4	12-1
Coat.....	12-5	12-1
Trousers.....	12-6	12-1
Vest, design.....	12-7	12-1
Headgear.....	12-8	12-1
Insignia.....	12-9	12-1
13. ACCESSORIES		
Belt, waist.....	13-1	13-1
Beret, wool, rifle green.....	13-2	13-1
Buttons.....	13-3	13-1
Cape, blue.....	13-4	13-1
Collar, white.....	13-5	13-2
Cover, cap, rain.....	13-6	13-2
Gloves.....	13-7	13-2
Hat, service (campaign).....	13-8	13-2
Laces, boot and shoe.....	13-9	13-2
Necktie.....	13-10	13-2
Overcoat.....	13-11	13-3
Overshoes, black.....	13-12	13-3
Raincoat.....	13-13	13-3
Scarf.....	13-14	13-3
Shirt.....	13-15	13-4
Shoes, low quarter, black.....	13-16	13-4
Shoulder knots.....	13-17	13-4
Socks, black.....	13-18	13-4
Studs and cuff links.....	13-19	13-4
14. INSIGNIA AND ACCOUTERMENTS		
Use.....	14-1	14-1
General description.....	14-2	14-1
Headgear ornamentation and insignia.....	14-3	14-1
"U.S." insignia.....	14-4	14-3
Insignia of grade for officers.....	14-5	14-3
Insignia of grade for warrant officers.....	14-6	14-5
Insignia for officer candidates.....	14-7	14-5
Insignia for warrant officer candidates.....	14-8	14-5
Insignia of grade for enlisted personnel.....	14-9	14-5
Insignia of grade worn by retired personnel.....	14-10	14-6
Authority for wearing insignia of branch.....	14-11	14-6
Insignia of branch—how worn.....	14-12	14-7
Description of insignia of branch.....	14-13	14-7
Insignia of aides.....	14-14	14-9
Permanent professors, registrar, and civilian instructors U.S. Military Academy.....	14-15	14-10
Organization shoulder sleeve insignia.....	14-16	14-10
Ranger tab.....	14-17	14-12
Combat leader's identification.....	14-18	14-12
Distinctive insignia; background trimming; airborne insignia; and flash.....	14-19	14-13
Aiguillette, service.....	14-20	14-14
Aiguillette, dress.....	14-21	14-14
Insignia, distinguishing, "U.S. Army".....	14-22	14-15
Service stripes.....	14-23	14-15
Organization shoulder sleeve insignia of former wartime unit.....	14-24	14-15
Oversea service bars (World War II, Korean Service, Vietnam Service, and the Dominican Republic).....	14-25	14-16

CHAPTER 14. INSIGNIA AND ACCOUTERMENTS—Continued	Paragraph	Page
Brassards.....	14-26	14-17
Acting officers' brassard.....	14-27	14-17
Acting noncommissioned officers' brassard.....	14-28	14-17
Armed Forces Police brassard.....	14-29	14-17
Explosive ordnance disposal brassard.....	14-30	14-17
Gas brassard.....	14-31	14-17
Geneva Convention brassard.....	14-32	14-17
Military Police brassard.....	14-33	14-17
Mourning brassard.....	14-34	14-17
Movement control brassard.....	14-35	14-17
Officer of day brassard.....	14-36	14-17
Officer of guard brassard.....	14-37	14-18
Photographer brassard.....	14-38	14-18
Port brassard.....	14-39	14-18
Trainees in leadership courses brassard.....	14-40	14-18
Unit police brassard.....	14-41	14-18
Veterinary Corps brassard.....	14-42	14-18
Colors of branches.....	14-43	14-18
Lapel buttons of organization insignia.....	14-44	14-18
Insignia for civilians.....	14-45	14-18
Distinctive items of uniform.....	14-46	14-19
Distinctive items authorized for infantrymen.....	14-47	14-19
Distinctive items authorized for personnel en route to new assignment or assigned to medical installations for treatment.....	14-48	14-20
Distinctive items authorized for personnel assigned to CONUS training divisions.....	14-49	14-20
Authorization for award of distinctive items for infantrymen.....	14-50	14-20
Issue of distinctive items for infantrymen.....	14-51	14-20
Distinctive items authorized for troops of branches other than Infantry.....	14-52	14-20
APPENDIX A. COMPOSITION OF UNIFORMS.....		A-1
B. CLOTHING ALLOWANCE ZONES (Map).....		B-1

CHAPTER 1

GENERAL

1-1. Purpose. This regulation prescribes the authorized material, design, ornamentation, insignia, accessories, manner, and occasion for the wearing of the uniform by all male personnel of the U.S. Army. Only uniforms and items prescribed herein or as issued will be worn. Personnel who wear the uniform will be held responsible for conformity to regulations. Wear of optional uniform items will be at the option of the individual and commanding officers will not require the purchase of unauthorized or optional uniform and insignia items unless specifically directed otherwise by Headquarters, Department of the Army. Except as otherwise prescribed, this regulation applies to all male military personnel of the Army except Generals of the Army; the Chief of Staff, U.S. Army; and former chiefs of staff, each of whom may prescribe the articles of uniform for his wear.

1-2. Wearing of uniform. *a.* The uniform will be worn when on duty by all male Army personnel in an active duty status except when special Department of the Army authority to wear civilian clothes on duty is granted. Military personnel accompanying U.S. Army forces in the field and normally authorized by Army regulation to wear civilian clothing on duty for security reasons will wear the insignia described in paragraph 14-45a (2) in lieu of insignia of grade or branch on the service or field uniform.

b. The Army uniform will not be worn when engaged in off-duty civilian employment except as provided in paragraphs 3-2 and 3-3.

c. Installation commanders will prescribe the wearing of the winter or summer service uniforms in conformance with AR 670-6.

d. The wearing of combinations of various articles of the uniform other than combinations prescribed by regulations and by tables of allowances is prohibited.

e. Except when specifically prohibited, uniform items changed in design or material may continue to be worn until no longer serviceable.

1-3. Wearing of civilian clothing. *a. CONUS.* Civilian clothing may be worn when off duty unless such wear is prohibited by the commanding general of a CONUS army, or the Commanding General, Military District of Washington, U.S. Army.

b. Overseas. Oversea commanders may authorize the off-duty wear of civilian clothing in areas within their command when deemed advisable.

1-4. Uniformity of material. *a.* When an individual exercises his option to choose among various fabrics authorized for the uniforms, he must be consistent so that the coat (or shirt when worn as an outer garment) and trousers are of the same type material. Garrison caps of Army Green shades 44 and 344 may be worn interchangeably with uniforms of either shade.

b. Wherever gold lace or gold bullion ornamentation and stripes are prescribed for wear with uniforms in this regulation, gold color nylon or rayon may be substituted subject to the following limitations:

- (1) If trouser and sleeve ornamentation is gold bullion, cap decoration and shoulder strap insignia must be bullion.
- (2) If trouser and sleeve ornamentation is of synthetic material, cap ornamentation and shoulder strap insignia may be of either bullion or synthetic material.
- (3) Ornamentation on visor of Army Green service cap will be of gold bullion.

1-5. Wearing of civilian decorations and jewelry. No jewelry, watch chains, or similar civilian items will appear exposed on the uniform. The only civilian decorations or ribbons which may be worn on the uniform are as authorized by AR 672-5-1.

1-6. Wearing of identification tags, security identification badges, nameplates, and name-tapes. *a. Tags, identification.* Identification tags will be worn by each member of the Army at all times when in the field, when engaged in field training, when traveling in aircraft, or when out-

side the continental limits of the United States. Wear of security badges outside of restricted areas is prohibited.

b. Badges, security identification. Security identification badges or cards may be worn in restricted areas as prescribed by the commanding officer.

c. Plate, name. Nameplates will be worn on the uniform when prescribed by the commanding officer. When prescribed, they will be provided without cost to the individual (CTA 50-901). Costs incurred in this connection are chargeable to OMA funds. Plates will conform to the following:

- (1) *Size.* 1 by 3 by $\frac{1}{16}$ inches (may be longer in case of lengthy names).
- (2) *Color.* Jet black background, with white border not to exceed $\frac{1}{32}$ -inch in width.
- (3) *Material.* Laminated plastic, nongloss finish.
- (4) *Lettering.* White, indented, block-type lettering $\frac{3}{8}$ -inch in height and centered on the plate. Use last name only.
- (5) *Attachment.* Clutch back.
- (6) *Placement.* To be worn on the flap of the right breast pocket, centered between the top of the button and the top of the pocket.

Note. Prior to 1 January 1970, obsolescent name plates are authorized for wear on an optional basis.

d. Tapes, name. Nametapes will be worn on the utility and field uniform. The tapes will be OG 107 with black, block letters, approximately $4\frac{1}{2}$ inches in length and 1-inch in width. Use last name only. When prescribed they will be worn on the upper right breast parallel to the ground ($\frac{1}{4}$ to $\frac{3}{8}$ inch above top point of pocket or comparable position on garment with no pocket) of the items of field clothing on which the insignia, distinguishing, "U.S. Army," is authorized. Soldiers upon entry into the service will be issued eight nametapes at Reception Stations. (Costs incurred in this connection are chargeable to OMA Funds.)

1-7. Distinctive uniforms and articles thereof. *a.* The following uniforms and articles thereof for male members of the U.S. Army are distinctive. Distinctive components of the uniforms are limited to caps, coats, jackets, and trousers except as indicated.

- (1) Army Green uniform.

- (2) Army Blue uniform.
- (3) Army White uniform.
- (4) Army White Mess uniform.
- (5) Army Blue Mess uniform.
- (6) Army Evening Dress uniform.
- (7) Cape, blue.
- (8) Distinctive Blue Band and Honor Guard uniform.
- (9) Beret, wool, rifle green.
- (10) Hat, service (campaign).
- (11) Overcoat, wool gabardine, Army Green, shade 44.
- (12) Raincoat, cotton/nylon oxford, Army Green, shade 274.
- (13) Badges. See AR 672-5-1.
- (14) Buttons, uniform, U.S. Army.
- (15) Medals, service and their appurtenances. See AR 672-5-1.
- (16) Military decorations and their appurtenances. See AR 672-5-1.
- (17) Insignia adopted by the Department of the Army (including black, gold, (or gold color)), or other braid which is indicative of grade.

b. Individuals will assure that distinctive uniform items, upon becoming unserviceable for wear by those individuals, will be mutilated, dyed, or otherwise changed so that the items no longer possess the characteristics of distinctive U.S. Army uniforms.

1-8. Wearing of headgear. *a. Garrison caps—officers and warrant officers.* The garrison caps prescribed in this regulation and included in the composition of the various uniforms prescribed herein (app A) are authorized for wear by officers and warrant officers only when the shirt is worn as an outer garment or when an individual officer or warrant officer is in a travel status away from his home station, except that installation commanders may prescribe wearing of the garrison cap during periods of extremely inclement weather. However, during periods of mobilization and active combat, the wear of the garrison cap rather than the service cap by officers and warrant officers is authorized but not required.

b. Protective headgear. The wearing of protective headgear of a commercial design with the uniform may be authorized by local commanders when considered appropriate for personnel operating a motorbike, motorcycle, or like vehicle.

12 February 1968

AR 670-5

1-9. Color of ornamentation and insignia for detailed officers. The colors of the ornamentation on the various dress uniforms of officers who are detailed to duty with branches other than their basic branch, including the General Staff Corps, will conform to the colors of their basic branch.

The insignia worn will be the insignia of the branch in which detailed.

1-10. Of adopted design. As used in this regulation, the phrase "of adopted design" means that there is a specific pattern which must be adhered to.



CHAPTER 2

RESPONSIBILITIES

2-1. Individual purchase of uniforms from commercial or exchange sources. Quality controlled uniform items are listed in AR 700-8400-3. Officers, warrant officers, and enlisted personnel purchasing uniforms from sources other than Army Clothing Sales Stores and/or Post Exchanges will insure that each item contains a certificate label warranting that the item has been produced from certified fabric and manufactured under a certificate issued by the U.S. Army Uniform Quality Control Office. The labels appearing in uniform items must incorporate the following:

This garment is warranted to meet or exceed the standards of specification(s) number ----- and was produced under certificate number ----- from basic material warranted by the manufacturer to have been produced in accordance with sample under current certificate.

2-2. Purchase of uniform items. *a.* All uniform items sold in Army Clothing Sales Stores conform to the specifications for required items.

b. All uniform items sold in Post Exchanges conform to the specification for required or optional items.

c. Personnel purchasing uniform items from other than the above two sources are advised to establish the reliability of the seller and to make sure that each garment contains the certificate label referred to in paragraph 2-1. Since Army Clothing Sales Stores and Post Exchanges operate at a low markup, individuals should be exceedingly cautious about purchasing items from commercial sources at bargain prices. These items may have been rejected by Government purchasers, may not conform to specifications, or may be in the process of being discontinued as approved items.

2-3. Officers and warrant officers. Major items of uniform clothing which are normally prescribed by commanders with minimum quantities that should be in possession of all officers are listed in AR 700-8400-1.

2-4. Enlisted men. Enlisted men will maintain initial allowances, and supplemental clothing allowances where issued, as prescribed in AR 700-8400-1.

2-5. Commanders. *a.* The commanding general of each CONUS army and the Commanding General, Military District of Washington, U.S. Army, will designate the prescribed or authorized uniform, as described in this regulation, to be worn within his respective command by all Army personnel except as follows:

- (1) The installation commander will prescribe the uniform for wear within the limits of his installation.
- (2) The Commander of units on maneuver will prescribe the uniform to be worn within the maneuver area.

b. CONUS commanders will not restrict or discourage the wearing of authorized optional items.

c. Oversea commanders may publish detailed uniform regulations, including the wear of civilian clothing, as circumstances warrant (Army component commanders may act in this capacity, as appropriate). However, individuals will not be required to wear any uniform item not authorized by this or other Army regulations, nor will they be required to purchase optional items.

d. Commanding officers will conduct inspections periodically to verify that personnel under their command are fully equipped with the uniforms prescribed and required by this regulation and applicable tables of allowances.

e. Commanding officers will insure that only uniform items bearing a proper certificate are worn, if purchased from sources other than Army Clothing Sales Stores and/or Post Exchanges, and if the item appears on the controlled list (AR 700-8400-3).

f. The correct fitting of uniforms is so necessary to the military appearance of a command that it is made the distinct duty of every commanding

officer, regardless of grade, personally to see that each member of his command is properly fitted with a neat and correct uniform.

g. Commanding officers will insure that only prescribed and authorized items of insignia and ornamentation are worn on the uniform.

CHAPTER 3

WEAR OF UNIFORM BY RESERVE COMPONENTS, RETIRED,
SEPARATED, AND CIVILIAN PERSONNEL

3-1. Occasions of ceremony. As used in this regulation, the phrase "occasions of ceremony" means occasions essentially of a military character at which the uniform is more appropriate than civilian clothing, e.g., military balls, military parades, military weddings, military funerals, memorial services, and meetings or functions of associations formed for military purposes, the membership of which is composed largely or entirely of honorably discharged veterans of the Armed Forces or of Reserve personnel. Authority to wear the uniform includes authority to wear the uniform while traveling to and from the ceremony, provided such travel in uniform can be completed on the day of the ceremony.

3-2. Army National Guard and Army Reserve. *a. Officers and warrant officers.*

- (1) *General.* Except as otherwise prescribed, officers and warrant officers of the Army National Guard and the Army Reserve will wear the uniform, including the insignia, prescribed for officers and warrant officers of the Regular Army, and will provide themselves with service uniforms and insignia of the branch in which commissioned or appointed, for use when ordered to active duty for training. Occasions when the uniform may be worn are as prescribed below.
- (a) *Within limits of the United States or its possessions.* Officers and warrant officers of the Army National Guard and the Army Reserve not on active duty in any status and within the limits of the States or its possessions may wear the uniform when—
 1. Participating in military drills, exercises, conferences, or ceremonies in an official capacity as a Reserve commissioned officer or warrant officer of the Army under competent orders.

2. Engaged in the military instruction or in attendance as a student under appropriate orders at any school or course of instruction under the auspices of the Armed Forces or the Reserve components thereof.
 3. Instructors at an educational institution conducting courses of instruction approved by the Armed Forces or when responsible for military discipline at like institutions.
 4. At social functions or informal gatherings of a military character.
 5. Enrolled as undergraduates in any educational institutions in which there is an active Reserve Officers' Training Corps unit or an established unit of the Army Reserve. Individuals may wear the uniform and insignia of their commissioned grade only upon such occasions as may be expressly desired or authorized by the Professor of Military Science or other proper official of the school concerned. Reserve officers attending institutions at which military training is required curricular activity are authorized and may be required to wear the uniform prescribed by the institution, including the insignia of any grade or rating held in the student unit.
 6. Army Reserve technicians who are also members of the Ready Reserve, cannot be required, but may wear the uniform while on duty in their Civil Service status.
- (b) *When outside limits of the United States or its possessions.* Officers and warrant officers of the Army National Guard and the Army Reserve not on

Active duty and outside the United States or its possessions will not, except when granted authority by the Department of the Army, wear the uniform. Such officers on occasions of military ceremony or other military functions may, upon reporting to the nearest Army attaché and having their status accredited, be granted authority to appear in uniform. In a country to which no Army attaché is accredited, authority to wear the uniform for a specific occasion should be obtained from the proper civil or military authorities of the country concerned.

- (c) In addition to the conditions set forth in (a) and (b) above, members of the Army National Guard may wear the prescribed uniform performing State service when authorized by the State adjutant general.
- (2) *U.S. Army Reserve officers serving on active duty as warrant officers or enlisted men.*
- (a) Warrant officers and enlisted men on the active list of the Army who hold commissions in the Army Reserve may wear the uniform of their grade in the Army Reserve when—
1. Undergoing voluntary training designed for Reserve officers which they have been authorized to take by proper authority, and in going to and returning from their training.
 2. Attending meetings or functions of associations, formed for military purposes, the membership of which is composed largely or entirely of officers of the U.S. Army or of former members of the service.
- (b) The uniform of the Reserve grade will not be worn by warrant officers and enlisted men on the active list of the Regular Army in an office of the Department of Defense, or at places where they would come in contact with troops of the Regular Army, or of the National Guard when called into Federal service, except when the wearer is on active

duty as a Reserve officer or as otherwise authorized above.

b. Enlisted. Members of the Army National Guard and the Army Reserve on active duty or ACDUTRA will wear the uniform and insignia of the branch to which they are assigned and when not on active duty or ACDUTRA may wear the prescribed uniform under conditions similar to those set forth in a(1) (a) above.

3-3. Retired officers, warrant officers, and enlisted men. *a.* Personnel on active duty will wear the uniform prescribed for persons on the active list.

b. Personnel not on active duty may wear the uniform when such wear is considered to be appropriate, but the uniform will be that prescribed for personnel of corresponding grade and branch on the active list. At their option on occasions of ceremony, personnel not on active duty may wear the uniform prescribed for personnel of corresponding grade and branch on the date of their retirement, but the two uniforms will not be mixed.

c. Shoulder sleeve insignia are not authorized for wear on the uniform of retired personnel not on active duty, except that the shoulder sleeve insignia of a former wartime unit may be worn in accordance with paragraph 14-24.

d. Retired personnel, of any component, not on active duty in any status, may not wear the uniform when they are instructors or when responsible for military discipline at an educational institution unless the educational institution is conducting courses of instruction approved by the Armed Forces.

3-4. Former members of the Armed Forces. The wearing of the uniform of the U.S. Army by former members thereof is permitted under the following circumstances:

a. Any person who has served honorably in the Army of the United States during war, whether declared or not, and whose most recent service was terminated under honorable conditions, shall, although not in the active military service of the United States, be entitled to bear the official title, upon occasions of ceremony, to wear the uniform of the highest grade held during his or her war service upon ceremonious occasions. The uniform to be worn by such persons, will be, at the option of the wearer, either that prescribed for persons of corresponding grade in his branch, the date of

separation from service or that prescribed for persons on the active list, except that uniforms will not be mixed.

b. The uniform may be worn upon the following occasions of ceremony:

- (1) Military funerals, memorial services, and inaugurations.
- (2) Patriotic parades on national holidays, or other military parades or ceremonies in which any active or Reserve U.S. military unit is taking part.

c. Persons who have been awarded the Medal of Honor are authorized to wear the uniform at any time except as prohibited in paragraph 3-5.

d. Authority to wear the uniform includes periods while traveling to and from the ceremony, provided such travel in uniform is performed within 24 hours of time of ceremony. When the uniform is worn under the provisions of this regulation by honorably discharged or separated personnel who served during World War II, the honorable discharge emblem will be worn on the right breast of all outer clothing centered immediately above the pocket.

e. A person discharged honorably or under honorable conditions from the Army may wear his uniform while going from the place of discharge to his home, within 3 months after his discharge.

f. Nothing in *a* above shall prevent the wearing of the uniforms when authorized under other provisions of Section 772, Title 10, United States Code. The prescriptions of paragraph 3-5 apply.

3-5. For members of the Armed Forces. The wearing of the uniform of any of the Armed Forces by members thereof (including retired members and members of Reserve components) is prohibited under any of the following circumstances:

a. At any meeting or demonstration which is a function of, or sponsored by any organization, association, movement, group, or combination of persons which the Attorney General of the United States has designated as totalitarian, fascist, communist, or subversive, or as having adopted a policy of advocating or approving the commission of acts of force or violence to deny others their rights under the Constitution of the United States, or as seeking to alter the form of Government of the United States by unconstitutional means.

b. During or in connection with the furtherance

of private employment or commercial interests when an inference of official sponsorship for the activity or interest would be drawn.

c. Under circumstances which would tend to bring discredit upon the Armed Forces.

d. Under such circumstances as may be specified and published by the Secretary of the military department concerned.

3-6. Civilians. *a.* Civilians attached to and/or authorized to accompany forces of the U.S. Army overseas, including Department of the Army civilian employees and civilian personnel of all U.S. military missions, will wear either the winter or summer service uniform with appropriate insignia, the authorized civilian uniforms as approved by the Secretary of the Army, or civilian clothes as prescribed by the commanding general of the command concerned.

b. The service uniform may be worn in the United States only when preparing for departure for or when on temporary duty from an overseas area where the commanding general has prescribed or authorized the wearing of the uniform.

c. The service uniform will be that prescribed for an officer or enlisted man as directed by the commanding general. The uniform will be worn without insignia except insignia prescribed for civilians in paragraph 14-45.

d. Representatives of civilian organizations authorized by the Secretary of the Army to engage in Armed Forces welfare activities will wear the uniform of their respective organizations when with the U.S. Army either at home or abroad, provided such uniform has been approved by the Secretary of the Army.

e. While attending a course of military instruction conducted by the Army, a civilian may wear the uniform prescribed by the Army.

3-7. Requirement for distinctive insignia. *a.* A person for whom one of the following uniforms is prescribed may wear it, if it includes distinctive insignia prescribed by the Secretary of the Army to distinguish it from the uniform of the Army:

(1) The uniform prescribed by the university, college, or school for an instructor or member of the organized cadet corps of—

(*a*) A State university or college, or a public high school, having a regular course of military instruction; or

- (b) An educational institution having a regular course of military instruction, and having a member of the Army as instructor in military science and tactics.
- (2) The uniform prescribed by a military society, composed of persons discharged honorably or under honorable conditions from the Army, to be worn by a member of that society when authorized by regulations prescribed by the Secretary of the Army.

b. A uniform prescribed under *a* above may not include insignia of grade the same as, or similar to, those prescribed for officers of the Army.

3-8. Retirement ceremonies. Recognition to retiring personnel who will be advanced to a higher grade upon retirement may be afforded by authorized wear of the insignia of such higher grade while participating in retirement ceremonies. However, since the retirement ceremony is in their honor, and performed at their request, requirement for wear will not be mandatory.

CHAPTER 4

FIELD AND WORK UNIFORMS

4-1. Composition. Commanding officers will prescribe the field or work uniform from appropriate items in CTA 50-901, and appendix I of AR 700-8400-1.

4-2. Additional articles for military police (fig. 4-1). *a.* Belt, military police, leather, black.
b. Brassard, military police.
c. Cap, service, military police, white.
d. Carrier, club, policeman's leather, black.
e. Case, field first aid dressing, leather, black.
f. Club, policeman's.
g. Gloves, cotton, white.
h. Lanyard, pistol, white.
i. Pocket, ammunition magazine, leather, black.
j. Shoulder strap, side arm, military, leather, black.

Note. Cover, service cap, armed forces police, may be worn until stocks are exhausted.

4-3. Boots, service, combat, black. Combat service boots will be worn in combat or simulated combat conditions, or when prescribed with the Army Green, Army Khaki, and field uniforms.

4-4. Chaplains' apparel. *a. Scarfs.*

- (1) *Christian faith.* A scarf of standard Army ecclesiastical pattern, of suitable black material 9 feet long. On each end, in gold color Schiffli embroidery, the coat of arms of the United States, 3 inches high, with the Chaplain's insignia, Christian, 4 inches high, spaced 1/2-inch below the coat of arms. The bottom of the insignia is to be 6 1/2 inches from the end of the scarf.
- (2) *Jewish faith.* A scarf of standard Army ecclesiastical pattern, of suitable white or black material 9 feet long. On each end, in gold color Shifli embroidery, the coat of arms of the United States, 3 inches high, with the Chaplain's insignia, Jewish, 4 inches high, spaced 1/2-inch below the coat of arms. The bottom of the in-

signia to be 6 1/2 inches from the end of the scarf.

b. Vestments. When conducting religious services, the chaplain is authorized to wear vestments which are required or customary in the denomination which the chaplain represents. When he does not wear such vestments, the chaplain will wear the uniform while conducting religious services.

4-5. Shirt and trousers, olive green, Army shade 108. These items are both basic components of the cold weather clothing ensembles. By design, these items are intended to be loose-fitting, but may be adjusted by means of their darts and tabs. Alterations to make these items form-fitting are not authorized. There are times in garrison, and in the field, when commanders may desire to designate the shirt and trousers as a uniform in accordance with paragraph 4-1. They should not be worn as outer garments if they will become unduly soiled, snagged, or otherwise damaged. When the shirt is worn as an outer garment, the shirt will be tucked into the trousers, and a belt rather than suspenders will be worn on the trousers.

4-6. Coats, shirts, and trousers, olive green.

a. Coat and trousers, cotton wind resistant poplin, olive green, Army shade 107. These items are basic components of the tropical combat uniform. They are intended to be loose-fitting, with the coat worn over the trousers, and a belt rather than suspenders will be worn on the trousers. Alterations to make these items form-fitting are not authorized, nor are other alterations such as cuffs, additional pockets, or flaps on sleeves. This uniform will not be starched. Sleeves will not be rolled or shortened, trousers will be bloused.

b. Shirt and trousers, cotton sateen, olive green, Army shade 107. These items are both basic components of the utility uniform. By design, these items are intended to be loose-fitting and the shirt will be tucked into the trousers and a belt rather than suspenders will be worn on the trousers.

Alterations to make these items form-fitting are not authorized. Shoulder straps, cuffs, and other alterations, such as pockets or flaps on sleeves, are not authorized. Sleeves will not be rolled, or shortened, trousers will be bloused.

4-7. Cap, utility, olive green, Army shade 106.

Only the following ornamentation may be authorized for wear:

a. Officers and warrant officers. Insignia of grade centered on front of cap.

b. Enlisted men. Distinctive unit insignia when applicable centered on front of cap.

4-8. Ornamentation. *a.* Only the following ornamentation may be authorized for wear on the field or work uniform:

- (1) Brassards.
- (2) Branch type scarfs.
- (3) Combat leaders identification (on shoulder loop only).
- (4) Distinctive unit insignia (worn on shoulder loop of coat, cotton/sateen, olive green, Army shade 107, and appropriate headgear only).
- (5) Combat and special skill badges (embroidered in lieu of metal items are authorized on an optional basis).
- (6) Insignia of branch (officers and warrant officers only).
- (7) Insignia, distinguishing, "U.S. Army."
- (8) Insignia of grade.
- (9) Nametapes.
- (10) Special military police markings.
- (11) Organizational shoulder sleeve insignia with tab when authorized, i.e., Airborne.
- (12) Ranger tab.

b. Wear of the above items will be as prescribed elsewhere in this regulation and AR 672-5-1.

c. Wearing of insignia on flight clothing by Army personnel may be prescribed locally by commanders. Type and location of insignia, if prescribed, should conform to placement of insignia on utility uniforms. Alternatively, in lieu of insignia, local commanders may authorize wear of a black leather plate, approximately 3 inches by 2 inches in size, with wings and the name and grade of the individual embossed in silver for wear on the flying suit and flying jacket.

d. Local commanders may authorize the wearing of solid color baseball caps by aircraft and ground crewmembers as a safety and identification

measure. No badges or insignia will be worn on such caps except insignia of grade for officers and warrant officers and distinctive insignia for enlisted personnel.

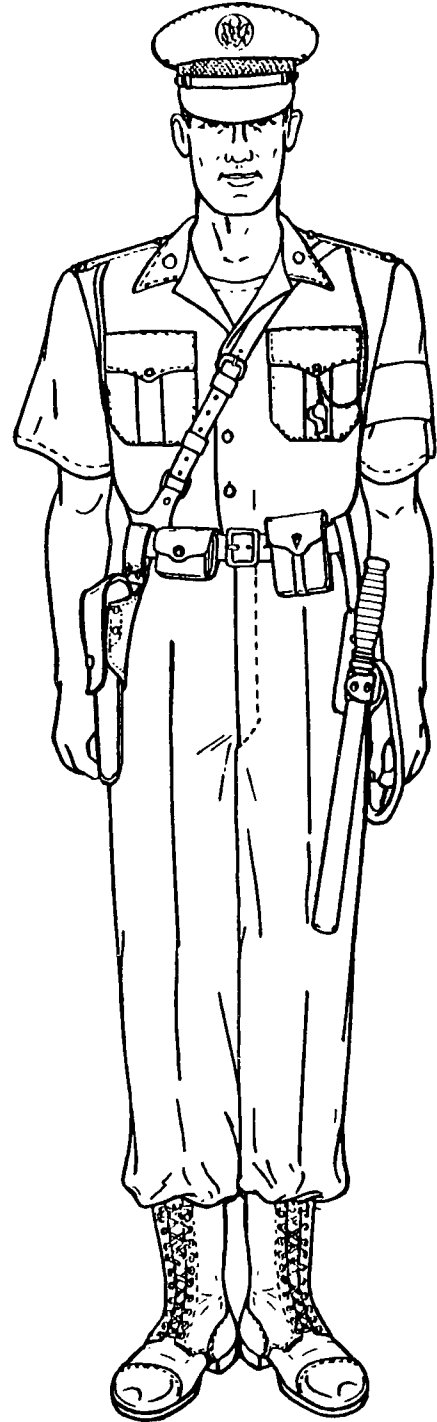

Figure 4-1. Additional articles for military police.

CHAPTER 5

ARMY KHAKI UNIFORM

5-1. Authorization for wear. The Army Khaki uniform is authorized for wear by officers, warrant officers, and enlisted men during the summer uniform season.

5-2. Composition. See appendix A.

5-3. Occasions for wear. *a. Army Khaki (conventional trousers with short sleeve shirt)* (fig. 5-1).

- (1) *Officers and warrant officers.* On duty.
- (2) *Enlisted men.*
 - (a) On duty.
 - (b) Off duty.
 - (c) During travel.

- (3) *When worn.* This uniform may be worn on a year-round basis by officers, warrant officers, and enlisted personnel when traveling to and from Hawaii, Okinawa, and Southeast Asia, while traveling between the aerial port and these areas.

b. Army Khaki (abbreviated). This uniform may be worn on post when not in formation. Authorization for off-duty wear of this uniform when outside military installations will be as determined by major commanders based on consideration of local custom, climate, and conditions of service.

5-4. Materials. *a. Shirt, short sleeve; trousers; and shorts.* Cotton uniform twill, 8.2 ounce weight, khaki, Army shade 1.

b. Socks. Combed, two-ply cotton knitting

yarn, and nylon reinforcing yarn; sand, Army shade 115.

5-5. Trousers (fig. 5-1). *a. Design.* Of adopted design.

b. Wear. With the Army Khaki uniform (conventional) or as authorized in paragraph 5-6b.

5-6. Shirt, short sleeve (fig. 5-2). *a. Design.* Of adopted design, with collar stand in back of neck only, collar leaves lying open and flat in front of neck, having no button or buttonhole at neck. Sleeves are short. On each shoulder a loop of same material as the shirt.

b. Wear. With conventional khaki trousers or with the Army Khaki uniform (abbreviated). Shirt will be worn tucked inside the trousers. (Collar insignia will be worn as shown in figure 5-1.)

5-7. Shorts, cotton, khaki (fig. 5-2). *a. Design.* Of adopted design, in length to a point between 1 and 2 inches above the top of the knee cap.

b. Wear. With the Army Khaki uniform (abbreviated).

5-8. Headgear. See paragraph 7-7.

5-9. Socks (fig. 5-2). *a. Design.* Seamless of sufficient length to provide for a turnover of 2½ to 3 inches at top, with top to reach a point about 1 inch below the bottom of the knee cap.

b. Wear. With the Army Khaki uniform (abbreviated).

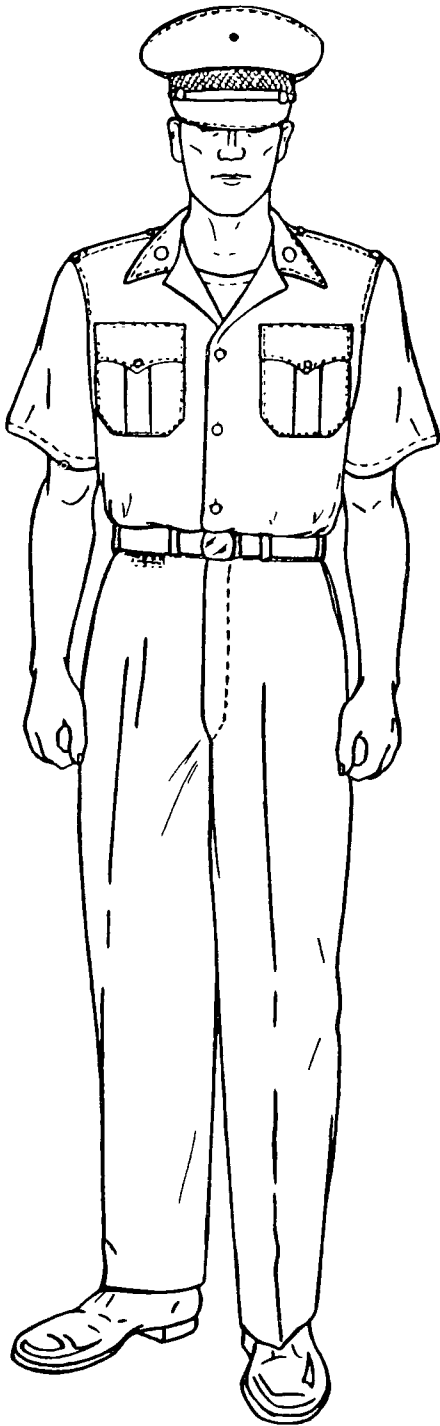

Figure 5-1. Army Khaki uniform.

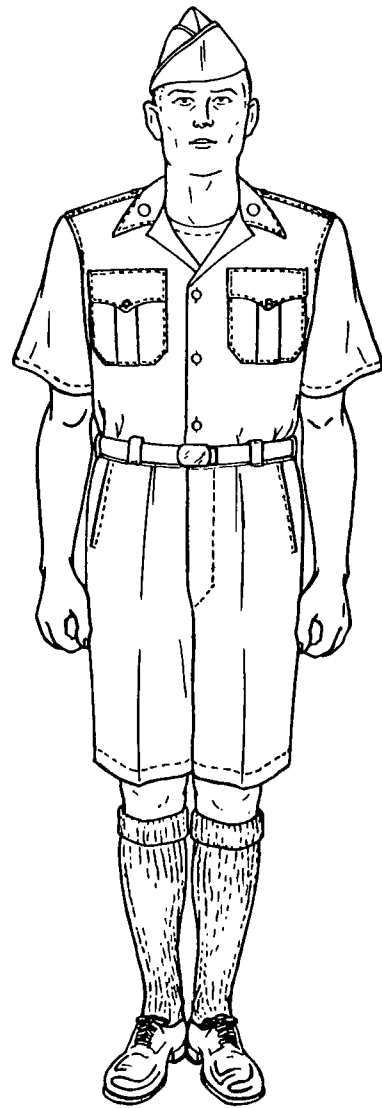

Figure 5-2. Army Khaki uniform.

CHAPTER 6

ARMY TAN UNIFORM

6-1. Authorization for wear. The Army Tan uniform is authorized for wear by officers, warrant officers, and enlisted men during the summer uniform season.

Note. This uniform becomes obsolete 31 December 1968.

6-2. Composition. See appendix A.

6-3. Occasions for wear. *a. Officers and warrant officers.*

- (1) On duty.
- (2) Off duty. This uniform may also be worn to social functions after retreat during appropriate season.
- (3) During travel.
- (4) The shirt will be worn as an outer garment in lieu of the coat within the limits of the installation when prescribed by the installation commander but will not be worn outside thereof, except when performing an assigned duty for which it is authorized by the installation commander, or by an individual traveling from his residence to place of duty and return.

b. Enlisted men (optional).

- (1) On Duty, except in formation.
- (2) Off duty.
- (3) During travel.

Note. The term "Army Tan," when used alone, means coat and trousers. When the Army Tan shirt is to be worn, it will be so specified. Only the coat and trousers of the uniform may be worn to social functions after retreat during the appropriate season.

6-4. Materials—coat, trousers, and shirt (outer garment), shade M-1 or Army shade 61.

- a.* Wool tropical, 9.5 or 10.5 ounce weight.
- b.* Wool gabardine, 11 ounce weight.
- c.* Polyester/wool blended fabrics in tropical weave, 9 ounce weight.
- d.* Polyester/wool blended fabrics in gabardine weave, 10.5 ounce weight.

6-5. Coat (fig. 6-1). *a. Design.* Of adopted design.

b. General description. A single-breasted, peaked-lapel, 4-button coat extending below the crotch, to fit easily over the chest and shoulders with slight drape effect in front and back. Coat to be fitted slightly at waist conforming with the figure without tightness and with no prominent flare.

c. Ormentation.

- (1) *Officers and warrant officers.* A band of khaki-color braid. Army shade 5, 1/2-inch in width on each sleeve, the lower edge 3 inches from end of sleeve.
- (2) *Enlisted men.* None.

6-6. Trousers, design (figs. 5-1 and 6-1). Of adopted design.

6-7. Shirt (outer garment) short sleeve. Of adopted design with collar stand in back of neck only, collar leaves lying open and flat in front of neck, having no button or buttonhole at neck and regular shirt tails at bottom. Sleeves are short. On each shoulder a loop of same material as the shirt. (This does not preclude the wear of the standard Army Tan shirt with shortened sleeves.)

6-8. Headgear. See paragraph 7-7.

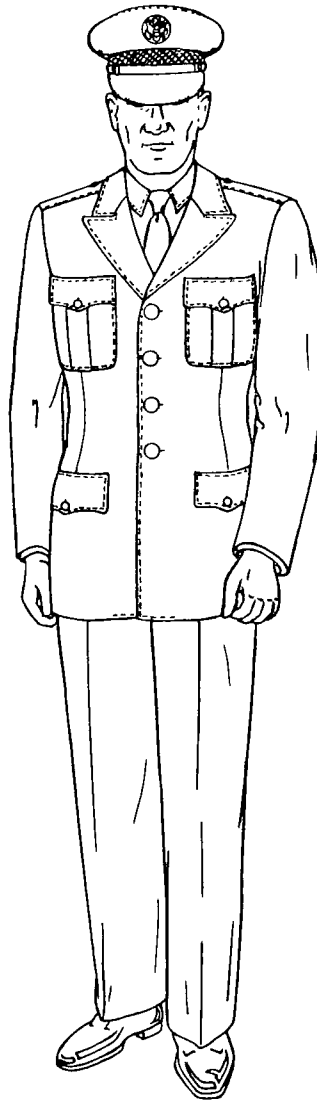

Figure 6-1. Army Tan uniform, Army Green uniform.

CHAPTER 7

ARMY GREEN UNIFORM

7-1. Authorization for wear. The Army Green uniform is authorized for year-round wear by officers, warrant officers, and enlisted men. It is the normal service uniform during the winter uniform season.

7-2. Composition. See appendix A.

7-3. Occasions for wear. *a. Officers and warrant officers.*

(1) The Army Green uniform is the prescribed general duty uniform. The wearing of this uniform during other than normal duty hours is also acceptable for social functions after retreat.

(2) As prescribed by local commanders.

(3) While in travel status.

b. Enlisted men.

(1) On duty.

(2) Off duty.

(3) During travel.

(4) As prescribed by local commanders.

7-4. Materials. *a. Coat and trousers.*

(1) *Officers and warrant officers.*

(a) Wool serge, 12 or 15 ounce weight, Army Green shade 44.

(b) Wool elastique, 16 ounce weight, Army Green shade 44.

(c) Wool gabardine, 11 ounce weight, Army Green shade 44.

(d) Polyester/wool blended fabric in gabardine weave, 9.5 ounce weight, Army Green shade 344.

(e) Polyester/wool blended fabric in tropical weave, 9 ounce weight, Army Green shade 344.

(2) *Enlisted men.* Same as (1) (a) and (e) above.

b. Headgear, cap.

(1) *Garrison.*

(a) *Officers and warrant officers.* Same as a(1) above.

(b) *Enlisted men.* Same as a(1) (a) and (e) above.

(2) *Service.*

(a) *Officers and warrant officers.* Fur felt approximately 9 ounce weight, Army Green shade 244.

(b) *Enlisted men.* Same as a(1) (a) above.

7-5. Coat (fig. 6-1). *a. Design.* Of adopted design.

b. General description. A single-breasted, peaked-lapel, four-button coat extending below the crotch, to fit easily over the chest and shoulders with slight drape effect in front and back. Coat to be fitted slightly at waist conforming with the figure without tightness and with no prominent flare.

c. Ornamentation.

(1) *General officers.* A band of black mohair braid $1\frac{1}{2}$ inches wide on each sleeve, the lower edge 3 inches up from end of sleeve.

(2) *Other officers and warrant officers.* Same as (1) above, except width of black braid is $\frac{3}{4}$ of an inch.

(3) *Enlisted men.* Without braid.

7-6. Trousers (fig. 6-1). *a. Design.* Of adopted design.

b. Ornamentation. On each outside seam from the bottom of the waistband to the bottom of the trouser leg.

(1) *General officers.* Two $\frac{1}{2}$ -inch wide black mohair stripes spaced $\frac{1}{2}$ -inch apart.

(2) *Officers and warrant officers.* One $1\frac{1}{2}$ -inch mohair stripe.

(3) *Enlisted men.* None.

7-7. Headgear, cap. *a. Garrison* (fig. 7-1).

(1) *Design.* Of adopted design with cord edge braid as prescribed in paragraph 14-3.

(2) *Insignia.* As prescribed in paragraph 14-3.

- (3) *Wear.*
- (a) *Officers and warrant officers.* With the Army Green, Army Tan, and Army Khaki uniforms as prescribed in paragraph 1-8.
 - (b) *Enlisted men.* With the Army Green, Army Tan, and Army Khaki uniforms.
 1. On duty.
 2. Off duty.
 3. During travel.
- (4) *Proper wear position.* Bottom of the front vertical crease of the cap at center of the forehead in straight line with the nose and at a point between 1 and 1½ inches above eyebrow level. The cap will then be tilted slightly to the right, but in no case will the side of the cap rest on the top of the ear. The cap will be placed on the head in such a manner that the front and rear vertical creases and the top edge of the crown form unbroken lines in silhouette. The crown will not be crushed or shaped to form peaks at the top front and top rear of the cap.
- b. *Service* (fig. 7-2).
- (1) *Design.* Of adopted design. Officers and warrant officers are authorized at their option to wear the cap frame with removable cover or the light-weight summer fur felt service cap.
 - (2) *Visor.* Of plain black leather, lined with embossed hatter's green prime leather. Poromeric material with leather finish is authorized for optional wear.
 - (a) *General and field grade officers* (①, fig. 7-2). Top of visor of black cloth embroidered in gold bullion with two arcs of oak leaves in groups of two.
 - (b) *Company grade officers, warrant officers, and enlisted men* (②, fig. 7-2). Top of visor to be plain black shell cordovan or shell cordovan finish leather; resin treated; with waterproof edge. Poromeric material with leather finish is authorized for optional wear.
 - (3) *Chin strap.* In two parts, each ½-inch in width, one end forming a slide and the other fastened to cap at end of visor.
 - (a) *Officers and warrant officers.* Of natural or light brown full grain pigskin or sheepskin, nonbleeding, covered with two-vellum gold wire lace, with pointed ends.
 - (b) *Enlisted men.* Of plain black leather, matching visor in appearance, with rounded ends. Poromeric material with leather finish is authorized for optional wear.
 - (4) *Cap insignia.* As prescribed in paragraph 14-3.
 - (5) *Wear, officers, warrant officers, and enlisted men.* With the Army Green, Army Tan, and Army Khaki uniforms.
 - (6) *Proper wear position.* Straight on the head so that the braid band on the cap creates a straight line around the head parallel to the ground. Such positioning of the cap on the head automatically positions the leather visor correctly so that it does not interfere with vision, nor ride up on forehead.

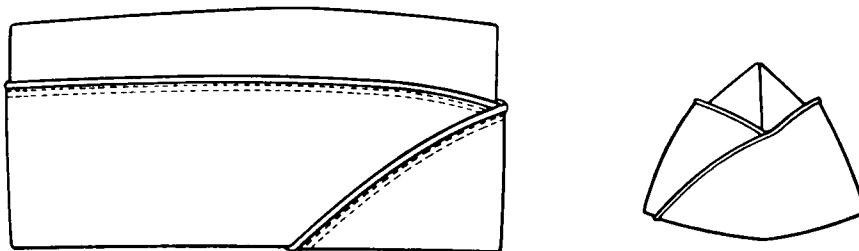
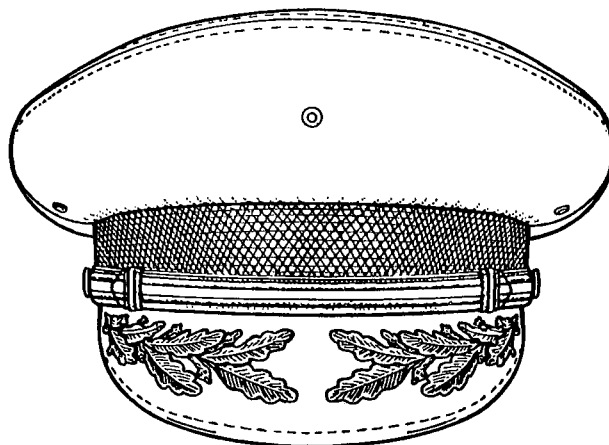
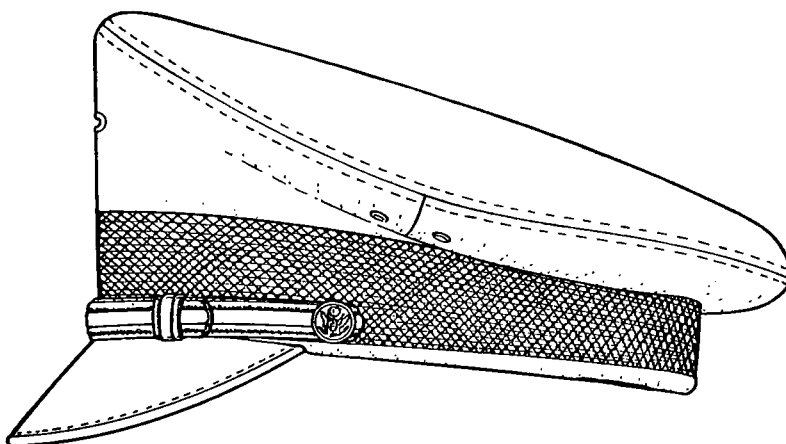

Figure 7-1. Cap, garrison.



① General and field grade officers.



② Company grade and warrant officers.

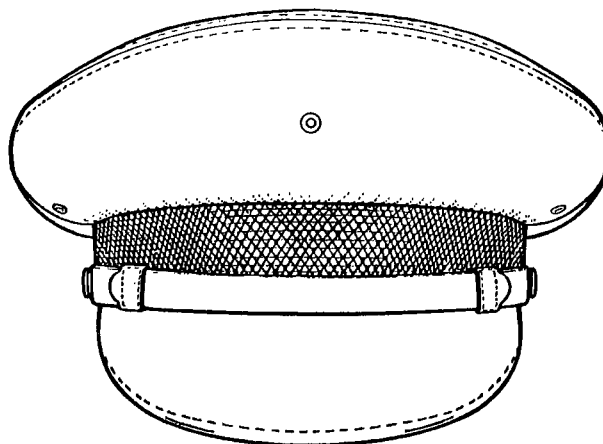

③ Enlisted men.

Figure 7-2. Cap service Army Green.

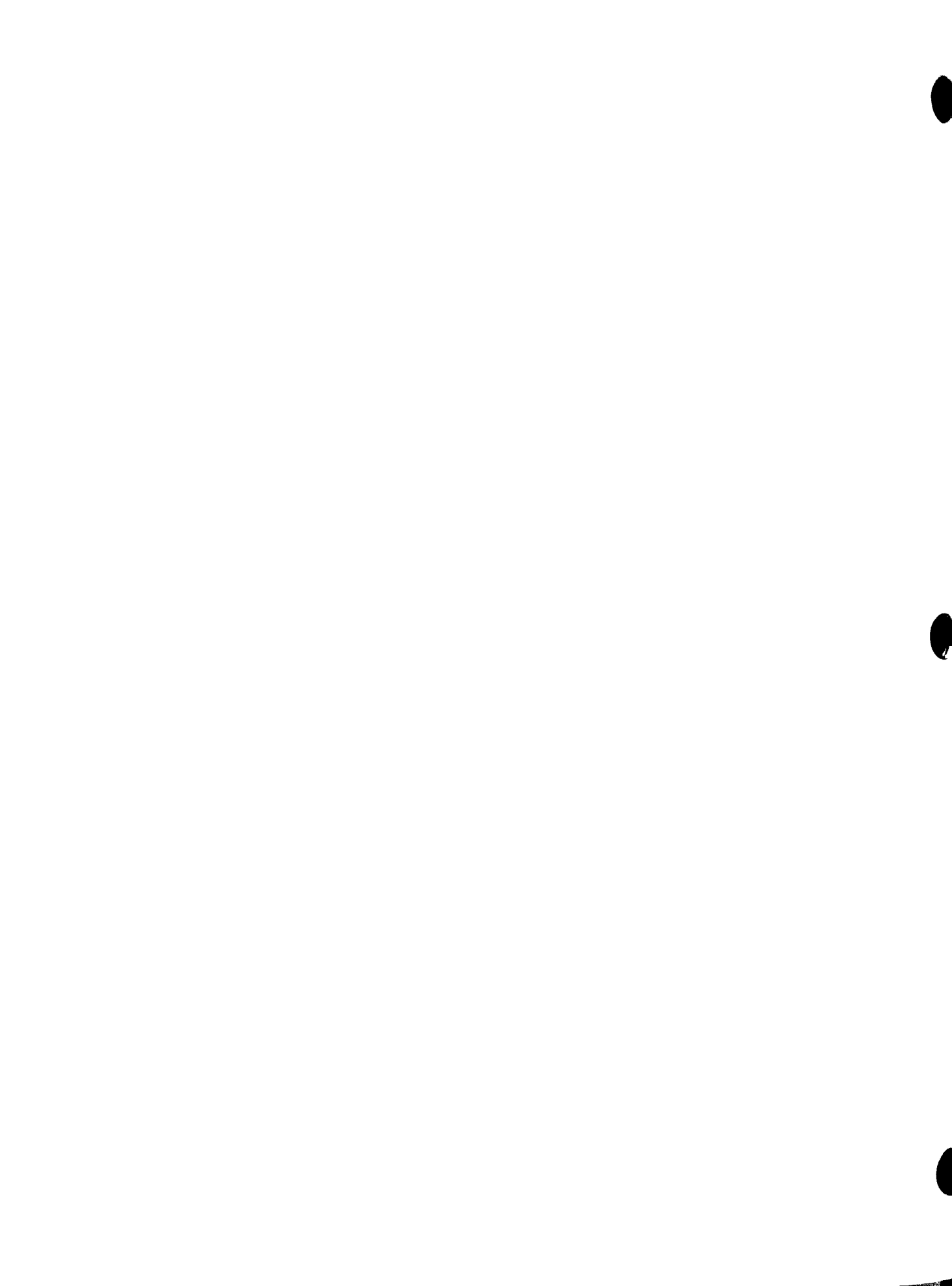

CHAPTER 8

ARMY WHITE UNIFORM

8-1. Authorization for wear. *a.* The Army White uniform is authorized for optional wear, except as provided in *b* below, by officers, warrant officers, and enlisted men without regard to dates prescribed for wear of summer and winter service uniforms.

b. All officers and warrant officers serving in Clothing Allowance Zones I and II, as defined in CTA 50-901, except those non-Regular Army officers who have 2 years or less to serve on their current tour of active duty or category commitment, will be required to own the Army White uniform and wear it on appropriate occasions. Major commanders are authorized to interpret and/or modify this policy to the extent warranted by local conditions existing within their respective commands.

8-2. Composition. See appendix A.

8-3. Occasions for wear. *a. Officers and warrant officers.*

- (1) As prescribed by local commanders in areas where possession of this uniform is required.
- (2) In other areas, on appropriate occasions as desired by the individual officer or warrant officer.

b. Enlisted men (optional).

- (1) On duty; when authorized by local commander.
- (2) Off duty.

8-4. Materials—coat, trousers, and headgear, cap, white. *a.* Cotton twill, 8.2 ounce weight.

b. Wool gabardine, 11 ounce weight.

c. Polyester/wool blended fabrics in plain (tropical type) weave, 9 ounce weight.

d. Polyester/viscose blended fabrics in gabardine weave, 8 ounce weight.

8-5. Coat (fig. 8-1). *a. Design.* Of adopted design.

b. General description. A single-breasted, peaked-lapel, 4-button coat extending below the crotch, to fit easily over the chest and shoulders with slight drape effect in front and back. Coat to be fitted slightly at waist conforming with the

figure without tightness and with no prominent flare.

c. Ornamentation.

- (1) *Officers and warrant officers.* A band of white cotton or mohair braid, appropriate to the uniform fabric, braid 1/2-inch in width on each sleeve, the lower edge 3 inches from end of sleeve.
- (2) *Enlisted men.* Without braid.

8-6. Trousers, design (fig. 8-1). Of adopted design.

8-7. Headgear, cap (fig. 8-1). *a. Design.* Of adopted design. Officers and warrant officers are authorized at their option to wear the cap frame with removable cover of the same material as the white coat.

- (1) *Visor.* Of black leather, lined with embossed, green, prime leather. Poromeric material with leather finish is authorized for optional wear.
 - (a) *General officers and field grade officers.* Top of visor of black cloth embroidered in gold or gold color nylon or rayon with two arcs of oak leaves in groups of two.
 - (b) *Company grade officers, warrant officers, and enlisted men.* Top of visor of plain black shell cordovan or shell cordovan finish leather, resin treated; with waterproof edge. Poromeric material with leather finish is authorized for optional wear.
- (2) *Chin strap.*
 - (a) *Officers and warrant officers.* Of natural or light brown full grain pigskin or sheepskin, nonbleeding, covered with two-vellum gold wire lace or gold color nylon or rayon, with pointed ends.
 - (b) *Enlisted men.* Of plain black leather, matching visor in appearance, with rounded ends. Poromeric material with leather finish is authorized for optional wear.

AR 670-5

(3) *Band (all personnel)*. An outside white braid $1\frac{3}{4}$ inches in width around the entire cap; bottom of body band covered with black cloth.

(4) *Cap insignia*. Same as worn on service caps (para 14-3).

b. Wear. By officers and warrant officers with the Army White and Army White Mess uniforms; by enlisted men with the Army White uniform.

8-8. Insignia. Only the following insignia are authorized for wear on the Army White uniform.

a. Officers and warrant officers.

- (1) U.S. insignia.
- (2) Insignia of grade.
- (3) Insignia of branch to which assigned or detailed.
- (4) Distinctive items authorized for infantrymen.

b. Enlisted men.

- (1) U.S. insignia.
- (2) Insignia of grade; same size and design as prescribed for service uniforms except on a white background matching coat.
- (3) Insignia of branch.
- (4) Distinctive items authorized for infantrymen.
- (5) Service stripes, diagonal stripes $\frac{1}{2}$ -inch wide gold color nylon or rayon. Service stripes are worn on the outside half of both sleeves, the first stripe to be sewed at an angle of 30 degrees, with lower end inserted in the front inside seam 3 inches above the bottom of the sleeve, and upper end inserted in the back seam of sleeve. Additional stripes are spaced $\frac{1}{8}$ -inch apart, above the first stripe.

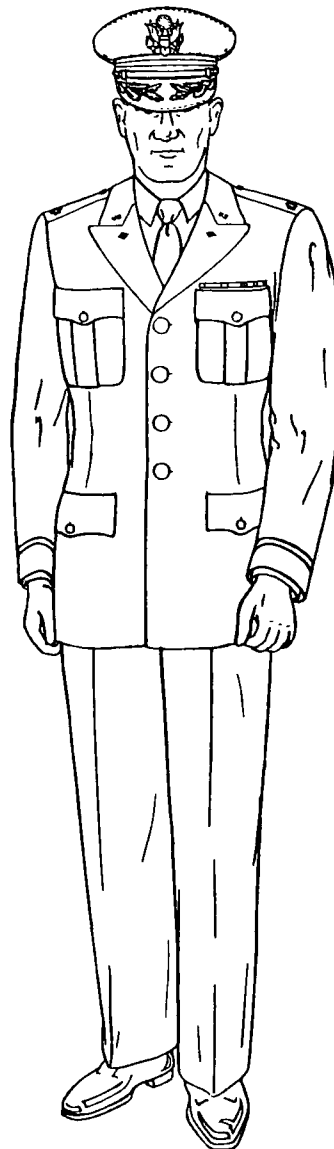

Figure 8-1. Army White uniform.

CHAPTER 9

ARMY BLUE UNIFORM

9-1. Authorization for wear. The Army Blue uniform is authorized for wear by officers, warrant officers, and enlisted men without regard for dates prescribed for wear of summer and winter service uniforms. Enlisted men will not wear the cape.

9-2. Composition. See appendix A.

9-3. Occasions for wear. *a. Officers and warrant officers.*

- (1) The Army Blue uniform is the prescribed uniform for social functions after retreat.
- (2) As prescribed by local commanders.
- (3) On other appropriate occasions as desired by the individual officer or warrant officer.

Note. All officers and warrant officers will be required to own the Army Blue uniform for wear on appropriate occasions except that Reserve component officers serving in a Reserve status or on active duty for training for periods of 6 months or less may purchase the Army Blue uniform on an optional basis.

b. Enlisted men (optional).

- (1) On duty—when authorized by local commander.
- (2) Off duty.

c. How worn. The Army Blue uniform may be worn with either a bow tie or a four-in-hand tie. When worn with a bow tie, the Army Blue uniform constitutes a dress uniform and corresponds to a civilian tuxedo. With the four-in-hand-type tie the Army Blue uniform is a semidress uniform.

9-4. Materials. *a. Coat.*

- (1) Wool barathea, 14 ounce weight, dark blue, Army shade 150.
- (2) Wool gabardine, 11 or 14.5 ounce weight, dark blue, Army shade 150.
- (3) Wool elastique, 16 ounce weight, dark blue, Army shade 150.
- (4) Wool tropical, 10.5 ounce weight, dark blue, Army shade 150.

(5) Polyester/wool blended fabric in gabardine weave, 9.5 ounce weight, dark blue, Army shade 150.

(6) Polyester/wool blend fabric in tropical weave, 9 ounce weight, dark blue, Army shade 150.

b. Trousers.

- (1) General officers. Same as *a* above, dark blue Army shade 150.
- (2) Other officers, warrant officers, and enlisted men. Same as *a* above sky blue, Army shade 151.
- (3) Optional purchase of the "high" or "low" waisted trousers is authorized.

c. Headgear, cap. Same as *a* above or fur felt approximately 9 ounce weight, dark blue, Army shade 250.

Note. Nylon gold color braid is more suitable than gold bullion on lightweight fabrics (11 ounce weight or less).

9-5. Coat (fig. 9-1). *a. Design.* Of adopted design.

b. General description. A single-breasted, peaked-lapel, 4-button coat extending below the crotch, to fit easily over the chest and shoulders with slight drape effect in front and back. Coat to be fitted slightly at waist conforming with the figure without tightness and with no prominent flare.

c. Shoulder buttons.

- (1) On uniforms of those authorized to wear the aiguillette, a button is attached to the body of the coat on left or right, depending on the position in which aiguillette is worn.
- (2) On uniforms of those authorized to wear the fourragere, a small regulation coat button is set in the left shoulder seam 1/2-inch outside the collar edge.

d. Shoulder, ornamentation (figs. 9-2 and 9-3).

- (1) *Shoulder straps* (for officers and warrant officers). On each shoulder strap is sewed

or snapped to the coat, centered, with a long side on the shoulder head seam.

- (a) *Design.* The shoulder strap is $1\frac{5}{8}$ inches wide and 4 inches long. The background is of blue-black velvet for general officers. For other officers, it is of wool facing cloth, silk or synthetic grosgrain or satin cloth of the first color of the officer's basic branch, and for warrant officers, brown. The strap has a gold or gold color nylon or rayon border $\frac{3}{8}$ -inch wide surrounded on the inside and outside by a single line of gold Jaceron. If the branch has two colors, the second named color is used as a $\frac{1}{8}$ -inch inside border in place of the inside line of Jaceron. (When gold color nylon or rayon is used, the Jaceron design is simulated.)
- (b) *Insignia of grade* (chap. 14). Insignia, embroidered, are placed on the strap.
1. *General officers.* Appropriate number of silver stars, $\frac{5}{8}$ -inch in diameter, embroidered on a blue-black velvet background. Each star is worn with one point toward the neck.
 2. *Colonel.* A silver spread eagle, $\frac{5}{8}$ -inch in height and $1\frac{1}{4}$ inches between tips of wings (straps are made in pairs with each eagle head looking to the front).
 3. *Lieutenant colonel.* A silver oak leaf $\frac{5}{8}$ -inch in height and $\frac{5}{8}$ -inch in width; one leaf on each end of strap.
 4. *Major.* A gold leaf $\frac{5}{8}$ -inch in height and $\frac{5}{8}$ -inch in width; on leaf on each end of strap.
 5. *Captain.* Two silver bars, each $\frac{1}{4}$ -inch in width and $\frac{5}{8}$ -inch in length, parallel to ends of strap, $\frac{3}{16}$ -inch apart and $\frac{3}{16}$ -inch from inside of border; one insignia on each end of strap.
 6. *First lieutenant.* One silver bar $\frac{1}{4}$ -inch in width and $\frac{5}{8}$ -inch in length parallel to ends of strap, $\frac{3}{16}$ -inch from inside of border; one insignia on each end of strap.
 7. *Second lieutenant.* One gold bar, $\frac{1}{4}$ -inch in width and $\frac{5}{8}$ -inch in length, parallel to ends of strap, $\frac{3}{16}$ -inch

from inside of border; one insignia on each end of strap.

8. *Warrant officer, grade 1.* One bar $\frac{1}{4}$ -inch in width, $\frac{3}{4}$ -inch in length, with a $\frac{5}{16}$ -inch latitudinal brown strip on each end of the bar, a $\frac{1}{8}$ -inch latitudinal center of gold $\frac{3}{16}$ -inch from inside of border. One insignia on each end of the strap.
 9. *Warrant officer, grade 2.* One bar $\frac{1}{4}$ -inch in width, $\frac{3}{4}$ -inch in length with a $\frac{1}{8}$ -inch latitudinal brown strip on each end of the bar; $\frac{1}{8}$ -inch latitudinal gold strip inward from each end of strip and a $\frac{1}{4}$ -inch brown latitudinal center $\frac{3}{16}$ -inch from inside of border. One insignia on each end of the strap.
 10. *Warrant officer, grade 3.* One bar $\frac{1}{4}$ -inch in width, $\frac{3}{4}$ -inch in length with a $\frac{5}{16}$ -inch latitudinal brown strip on each end of the bar, and a $\frac{1}{8}$ -inch latitudinal center of silver, $\frac{3}{16}$ -inch from inside of border. One insignia on each end of the strap.
 11. *Warrant officer, grade 4.* One bar $\frac{1}{4}$ -inch in width, $\frac{3}{4}$ -inch in length with a $\frac{1}{8}$ -inch latitudinal brown strip on each end of bar, $\frac{1}{8}$ -inch latitudinal silver strip inward from each end strip and a $\frac{1}{4}$ -inch brown latitudinal center $\frac{3}{16}$ -inch from inside of border. One insignia on each end of the strap.
- (2) *Shoulder loops (for enlisted men).*
- (a) *Material.* Loops must be of same material as that used for the coat.
 - (b) *Design.* A loop $2\frac{1}{4}$ inches wide at the lower end and $1\frac{1}{2}$ to $1\frac{3}{4}$ inches wide at the collar edge, piped all around with gold color nylon or rayon cord edge braid $\frac{1}{8}$ -inch wide. Braid to be inserted in the joining seams completely around each loop. Loop to be sewed in at the sleeve head seam, extending about $\frac{1}{2}$ -inch away from the outside collar edge. Loop to have a buttonhole and to be buttoned with a small 25-line ($\frac{5}{8}$ -inch) regulation coat button placed $\frac{3}{8}$ -inch from the finished edge of loop.

e. Sleeve, ornamentation. Gold lace or gold color nylon or rayon ornamentation is authorized for officers and warrant officers, provided the trouser stripes and sleeve stripes are of the same material (para 1-4). Gold color nylon or rayon ornamentation is authorized for enlisted men.

- (1) *General officers.* On each sleeve, one 1½-inch two-vellum gold lace or gold color nylon or rayon stripe, the bottom of the stripe 3 inches above the bottom of the sleeve.
- (2) *Other officers.* On each sleeve, two ¼-inch two-vellum gold lace or gold color nylon or rayon stripes placed ¼-inch apart over a silk stripe of the first named color of their basic branch, the bottom of the lower stripe 3 inches above the bottom of the sleeve.
- (3) *Warrant officers.* On each sleeve, two ¼-inch two-vellum gold lace or gold color nylon or rayon stripes placed ¼-inch apart over a brown silk stripe, the bottom of the lower stripe 3 inches above the bottom of the sleeve.
- (4) *Enlisted men.* On each sleeve a ½-inch stripe of gold color nylon or rayon soutache braid, parallel to and 3 inches above the bottom of the sleeve.

9-6. Trousers (fig. 9-1). *a. Design.* Of adopted design.

b. Ornamentation. On each outside seam from bottom of waistband to bottom of trouser leg.

- (1) *General officers.* Two ½-inch stripes of two-vellum gold lace or of two-vellum gold color nylon or rayon braid, spaced ½-inch apart.
- (2) *Other officers and warrant officers.* A stripe of two-vellum gold lace or of two-vellum gold color nylon or rayon braid 1½ inches in width.
- (3) *Enlisted men.* A stripe of two-vellum gold nylon or rayon braid 1½ inches in width.

Note. Optional purchase of the "high" or "low" waisted trousers is authorized.

9-7. Headgear, cap (figs. 9-4 and 9-5). *a. Design.*

- (1) *Of adopted design.* Officers and warrant officers are authorized at their option to wear the cap frame with removable cover.
- (2) *Visor.* Of black leather, lined with embossed, green, prime leather. Poromeric

material with leather finish is authorized for optional wear.

- (a) *General officers and field grade officers* (① and ②, fig. 9-4). Top of visor of black cloth embroidered in gold or gold color nylon or rayon with two arcs of oak leaves in groups of two.
- (b) *Company grade officers, warrant officers, enlisted men* (①, ②, and ③, fig. 9-5). Top of visor of plain black shell cordovan or shell cordovan finish leather, resin treated; with waterproof edge. Poromeric material with leather finish is authorized for optional wear.
- (3) *Chin strap.* In two parts each ½-inch in width, one end forming a slide and the other fastened to a cap at end of visor.
 - (a) *All officers and warrant officers.* Of natural or light brown full grain pigskin or sheepskin, nonbleeding, covered with two-vellum gold bullion lace or gold color nylon or rayon, with pointed ends.
 - (b) *Enlisted men.* Of plain black shell cordovan leather matching visor in appearance, with rounded ends. Poromeric material with leather finish is authorized for optional wear.
- (4) *Band.* An outside band 1¾ inches in width around the entire cap.
 - (a) *General officers* (①, fig. 9-4). Of blue-black velvet with oak leaves, in groups of two, about 1 inch in length and ¾-inch in width, embroidered in gold or gold color nylon or rayon.
 - (b) *Other officers and warrant officers* (① and ②, fig. 9-5). Of grosgrain silk of the first named color of the officer's basic branch (warrant officers—brown), with a band of two-vellum gold or gold color nylon or rayon ½-inch in width at top and bottom; if the branch has two colors, a ⅛-inch piping of the second color on the inside edges of the gold bands.
 - (c) *Enlisted men* (③, fig. 9-5). Of basket weave mohair braid matching the shade of the cap material with a band of two-vellum gold color nylon or rayon braid ½-inch in width at top.

(5) *Cap insignia.* Same as worn on service caps (para 14-3).

b. Wear.

(1) *Officers and warrant officers.* With the Army Blue, Army Blue Mess, and Army Evening Dress uniforms.

(2) *Enlisted men.* With the Army Blue uniform.

9-8. Insignia (chap. 14). Only the following insignia are authorized for wear on the Army Blue uniform:

a. Officers and warrant officers.

- (1) U.S. insignia.
- (2) Insignia of grade.
- (3) Insignia of branch to which assigned or detailed.
- (4) Distinctive items authorized for infantrymen.

b. Enlisted men.

- (1) U.S. Insignia.
- (2) Insignia of grade; same size and design as prescribed for service uniforms except of gold color nylon or rayon on dark blue background matching coat.
- (3) Insignia of branch.
- (4) Distinctive items authorized for infantrymen.
- (5) Service stripes, diagonal stripes $\frac{1}{2}$ -inch wide gold color nylon or rayon. Service stripes are worn on the outside half of both sleeves, the first stripe to be sewed at an angle of 30 degrees, with lower end inserted in the front inside seam $\frac{1}{4}$ -inch above cuff braid and upper end inserted in the back seam of sleeve. Additional stripes are spaced $\frac{1}{8}$ -inch apart, above the first stripe.

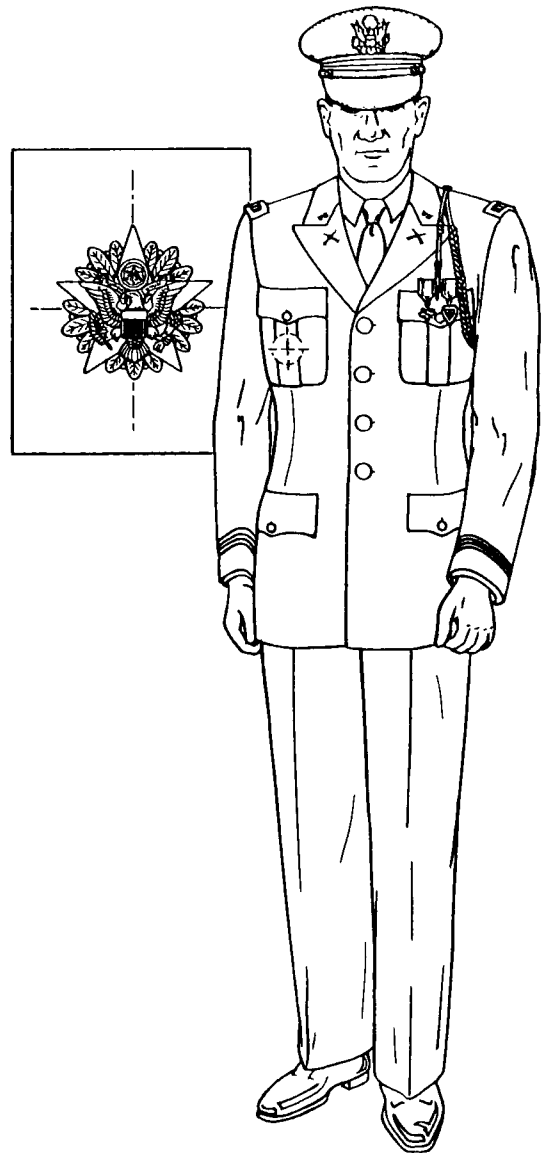
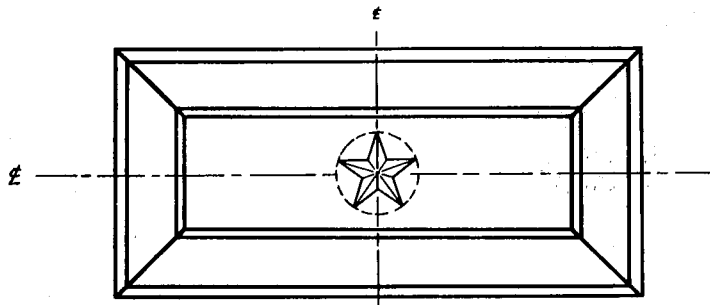
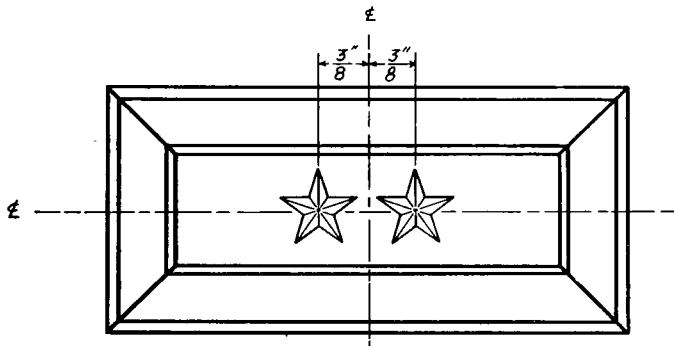
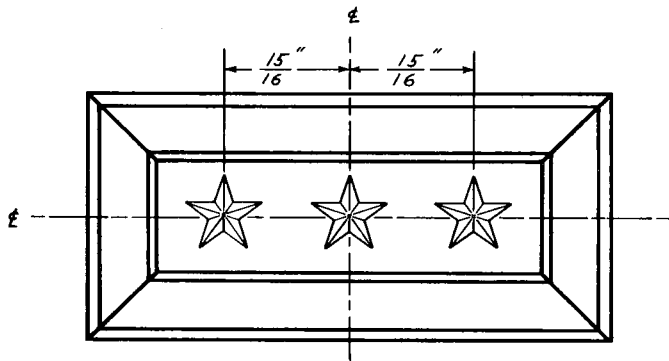
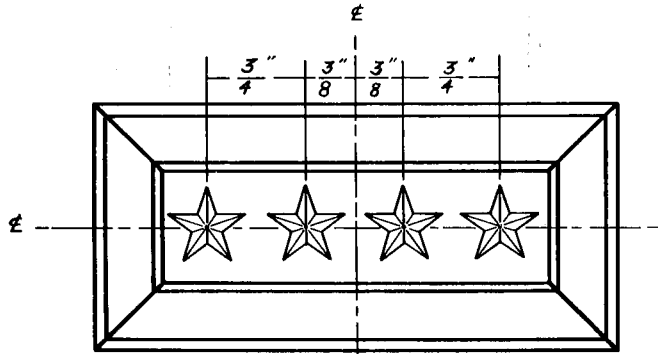
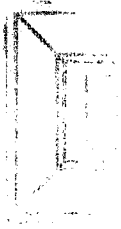

Figure 9-1. Army Blue uniform.



9-2. Shoulder ornamentation for Army Blue uniform.

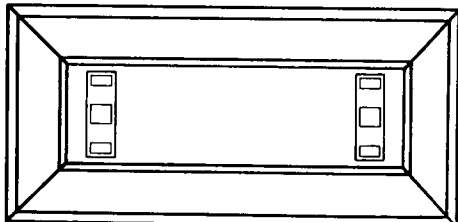
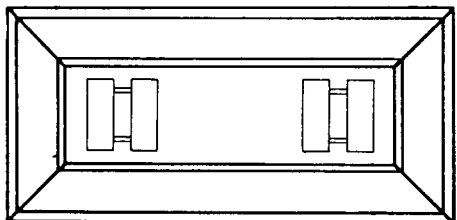
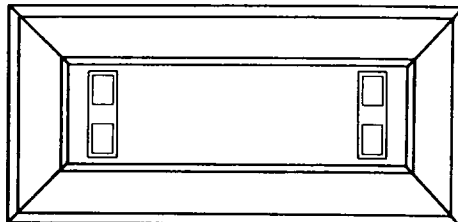
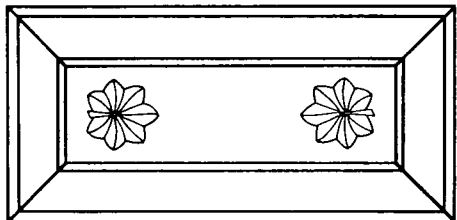
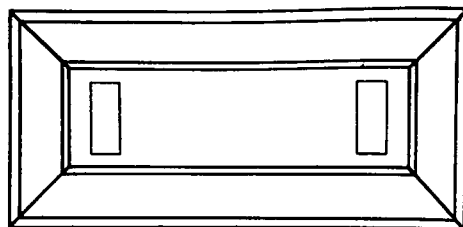
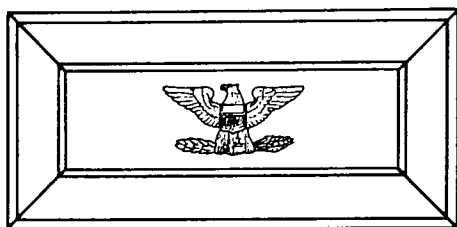
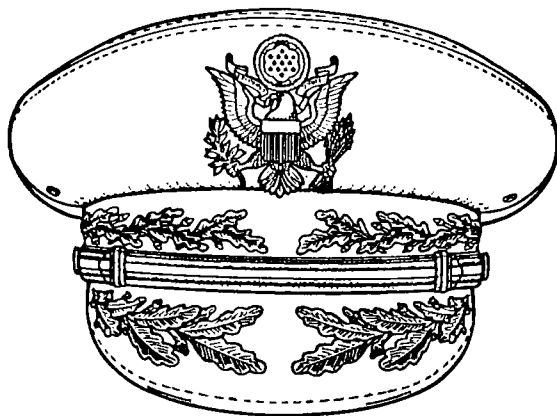
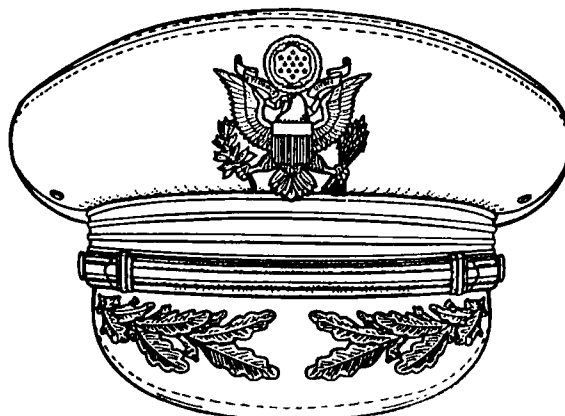

Figure 9-3. Shoulder ornamentation for Army Blue uniform.



① Cap, service general officer.



② Cap, service, field grade officers.

Figure 9-4. Cap, service, Army Blue.

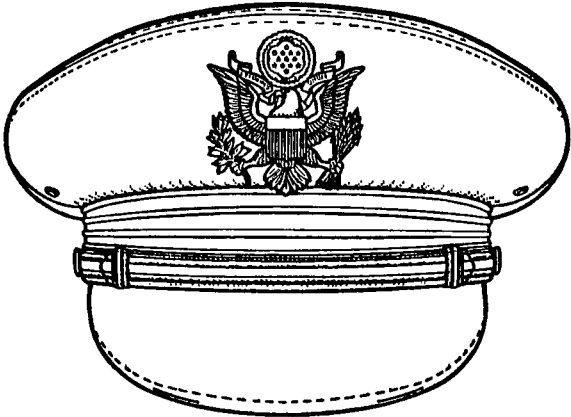

① Cap, service, company grade officers.

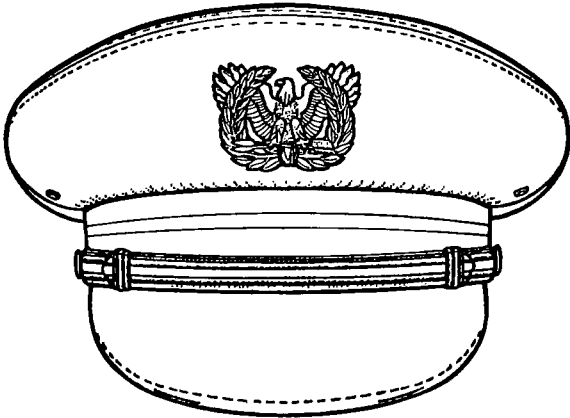

② Cap, service, warrant officer.

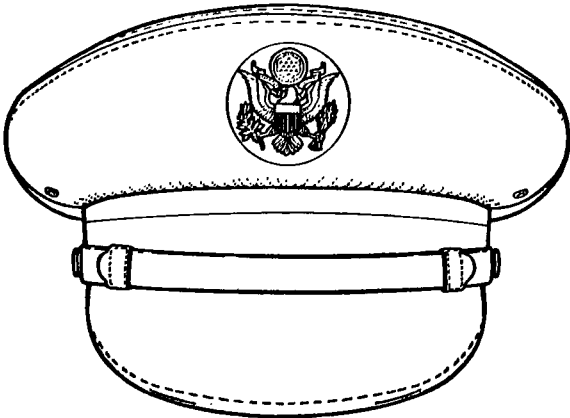

③ Cap, service, enlisted men.

Figure 9-5. Cap, service, Army Blue.

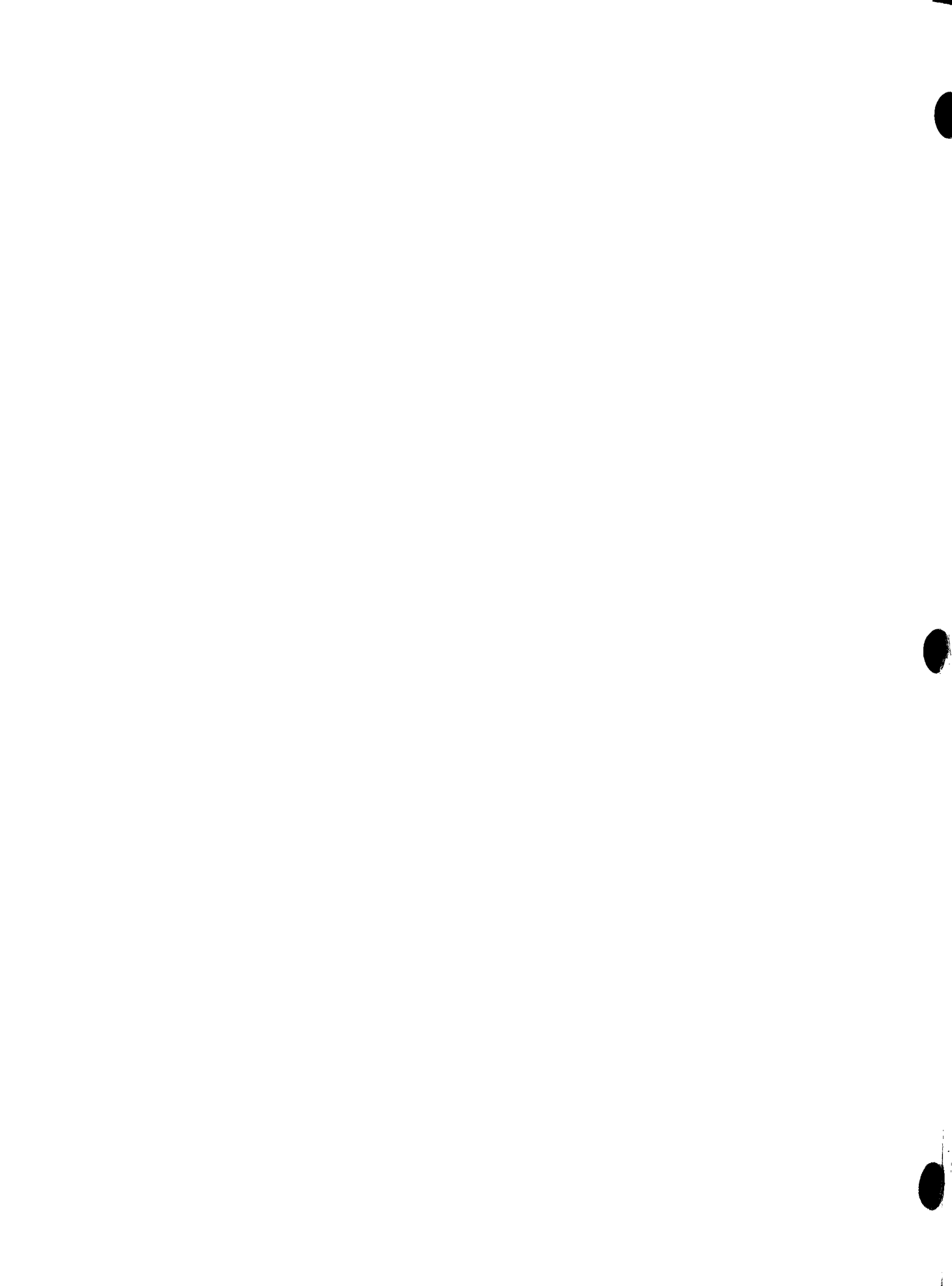

CHAPTER 10

ARMY WHITE MESS UNIFORM

10-1. Authorization for wear. *a.* The Army White Mess uniform is authorized for optional use, except as provided in *b* below, by officers and warrant officers without regard to dates prescribed for wear of summer and winter service uniforms.

b. All officers and warrant officers serving in the Clothing Allowance Zones I and II, as defined in CTA 50-901, except those non-Regular Army officers who have 2 years or less to serve on their current tour of active duty or category commitment, will be required to own the Army White Mess uniform and wear it on appropriate occasions. Major commanders are authorized to interpret and/or modify this policy to the extent warranted by local conditions existing within their respective commands.

10-2. Composition. See appendix A.

10-3. Occasions for wear. *a.* Social functions of a general or official nature after retreat.

b. Private formal dinners and other private formal social functions after retreat.

c. As prescribed by local commanders in areas where possession of this uniform is required.

10-4. Materials. *a. Jacket, white.*

- (1) Cotton, twill, 8.2 ounce weight.
- (2) Wool tropical, 10.5 ounce weight.
- (3) Wool gabardine, 11 ounce weight.
- (4) Polyester/wool blended fabrics in plain (tropical type) weave, 9 ounce weight.
- (5) Polyester/wool blended fabrics in gabardine weave, 10.5 ounce weight.

b. Trousers. Black lightweight material.

c. Vest. Of same material as Army White Mess jacket (11 ounce weight or less) or with cotton pique.

10-5. Jacket (fig. 10-1). *a. Design.* Of adopted design.

b. General description. Cut on the lines of an evening dress coat, to descend to point of hips, and slightly curved to a peak behind and in front. Two 25-line coat buttons, joined by a small gold or gold color chain about 1½ inches long, may be worn in

upper buttonholes. To be provided with a means of attaching shoulder knots.

c. Shoulder knots. (Same as for Army Blue Mess and Army Evening Dress uniforms.)

d. Ornamentation, sleeve.

- (1) *General officers.* A cuff of heavy white braid 4 inches in width, 1 inch above the upper edge of sleeve cuff is the insignia of grade. When general officers also wear the insignia of branch, it is placed 1 inch above the upper edge of cuff and insignia of grade is 1 inch above the insignia of branch. (Insignia of branch and grade may be metal or embroidery.) The stars are worn with one point upward; they are 1 inch in diameter, with the exception of stars of insignia of General of the Army, which are ¾-inch diameter.

(a) *General of the Army.* See paragraph 11-5e(1)(a).

(b) *General.* See paragraph 11-5e(1)(b).

(c) *Lieutenant general.* See paragraph 11-5e(1)(c).

(d) *Major general.* See paragraph 11-5e(1)(d).

(e) *Brigadier general.* See paragraph 11-5e(1)(e).

- (2) *Other officers.* On each sleeve a band of white braid ½-inch in width, the lower edge 3 inches from the end of the sleeve, surmounted by insignia of grade and insignia of branch. The insignia of grade consists of a knot composed of three loops, one larger upper and two smaller lower loops, formed by a varying number of rows (according to grade as listed below) of ⅛-inch white soutache braid, interlaced at points of crossing, ends of knots resting on the sleeve band. The insignia of branch (metal or embroidery) will be worn in the center of the space formed

by the lower curves of the knot and the upper edge of the sleeve band.

- (a) *Colonel*. See paragraph 11-5e(2) (a).
 - (b) *Lieutenant colonel*. See paragraph 11-5e(2) (b).
 - (c) *Major*. See paragraph 11-5e(2) (c).
 - (d) *Captain*. See paragraph 11-5e(2) (d).
 - (e) *First lieutenant*. See paragraph 11-5e(2) (e).
 - (f) *Second lieutenant*. See paragraph 11-5e(2) (f).
- (3) *Warrant officers*. See paragraph 11-5e(3).

10-6. Trousers, design (fig. 10-1). Cut on the lines of civilian dress trousers with a high waist, with or without pleats and with black silk or satin stripe, without cuffs and hip pocket.

10-7. Vest. a. Design. Single-breasted, cut low, with rolling collar, pointed bottom, and fastened with three detachable, extra-small, white buttons.

b. Optional. A black cummerbund may be worn in lieu of the vest.

10-8. Headgear. See paragraph 8-7.

10-9. Insignia. Only the following insignia are authorized for wear on the white mess uniform:

a. Insignia of grade.

b. Insignia of branch to which assigned or detailed.

c. Distinctive insignia and trimmings. Distinctive insignia and trimmings are centered on lapels of jacket; upper edge of insignia is $\frac{5}{8}$ -inch below the notch. (Distinctive insignia is not worn if miniature decorations and medals are worn.)

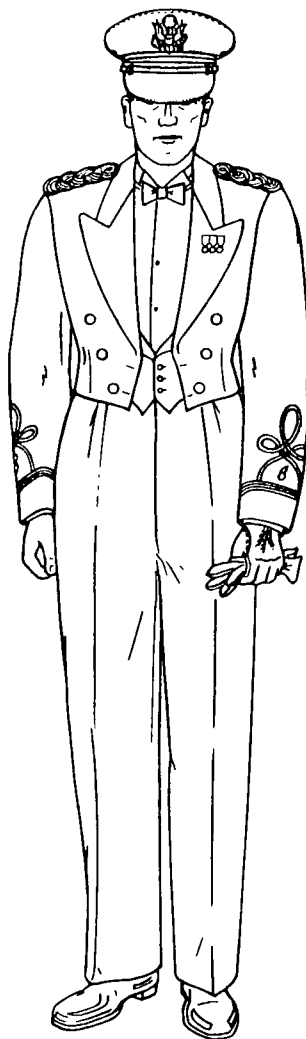

Figure 10-1. Army White Mess Uniform.

CHAPTER 11

ARMY BLUE MESS UNIFORM

11-1. Authorization for wear. The Army Blue Mess uniform is authorized for optional wear by officers and warrant officers without regard to dates prescribed for wear of summer and winter uniforms.

11-2. Composition. See appendix A.

11-3. Occasions for wear. *a.* Social functions of a general or official nature after retreat.

b. Private formal dinners and other private formal social functions after retreat.

11-4. Materials. *a. Jacket.*

- (1) Wool barathea, 14 ounce weight, dark blue, Army shade 150.
- (2) Wool, gabardine, 11 or 14.5 ounce weight, dark blue, Army shade 150.
- (3) Wool, elastique, 16 ounce weight, dark blue, Army shade 150.
- (4) Wool, tropical, 9 ounce weight, dark blue, Army shade 150.
- (5) Polyester/wool blended fabric in gabardine weave, 9.5 ounce weight, dark blue, Army shade 150.
- (6) Polyester/wool blended fabric in tropical weave, 10.5 ounce weight, dark blue, Army shade 150.

Note. Nylon gold color braid is more suitable than gold bullion on lightweight fabrics (11 ounce weight or less).

b. Trousers.

- (1) *General officers.* Same as *a* above.
- (2) *Other officers and warrant officers.* Same as *a* above, sky blue, Army shade 151.

c. Vest. White cotton pique.

11-5. Jacket (fig. 11-1). *a. Design.* Of adopted design.

b. General description. Cut on the lines of an evening dress coat, to descend to point of hips, slightly curved to a peak behind and in front. Two 25-line buttons, joined by a small gold or gold color chain about 1½ inches long, may be worn in upper buttonholes. Jacket is to be provided with a means of attaching shoulder knots.

c. Lapels. Color of facings.

- (1) *General officers except chaplains.* Dark blue.
- (2) *Chaplains.* Black.
- (3) *Other officers.* The first named color of basic branch.
- (4) *Warrant officers.* Brown.

d. Shoulder knots. Of gold bullion cord or gold nylon or rayon cord ¼-inch in diameter.

e. Ornamentation, sleeve.

- (1) *General officers* (fig. 11-2). A cuff of blue-black velvet 4 inches in width, with a band of oak leaves in groups of two, about 1 inch in width, embroidered in gold or gold color nylon or rayon, placed 1 inch below the upper edge of sleeve cuff. General officers' insignia of grade is placed 1 inch above the upper edge of the sleeve cuff. When general officers also wear the insignia of branch, it is placed 1 inch above the upper edge of cuff, and insignia of grade is 1 inch above the insignia of branch. (Insignia of branch and grade may be metal or embroidery.) The stars are worn with one point upward; they are 1 inch in diameter, with the exception of stars of insignia of General of the Army, which are ¾-inch in diameter.

(*a*) *General of the Army* (①, fig. 11-2).

Five stars fastened together in a circle, inner points touching, in center of sleeve.

(*b*) *General* (②, fig. 11-2). Four stars, 1¼ inches between centers, centered horizontally on outside half of sleeve.

(*c*) *Lieutenant general*. (③, fig. 11-2). Three stars, 1¾ inches between centers, center star in center of sleeve.

(*d*) *Major general* (④, fig. 11-2). Two stars, 2 inches between centers, centered horizontally on sleeve.

(*e*) *Brigadier general*. (⑤, fig. 11-2). One

star centered horizontally on sleeve.

- (2) *Other officers* (fig. 11-3). On each sleeve a band of two $\frac{1}{4}$ -inch two-vellum gold lace or gold color nylon or rayon stripes placed $\frac{1}{4}$ -inch apart over a grosgrain stripe of the first-named color of their basic branch; the bottom of the sleeve band to be 3 inches above the bottom of sleeve, to be surmounted by the insignia of grade and the insignia of branch. The insignia of grade consists of a knot composed of three loops, one larger upper and two smaller lower loops, formed of a varying number of rows (according to grade as listed below) of $\frac{1}{8}$ -inch gold or gold color nylon or rayon braid, interlaced at points of crossing, ends of knots resting on the sleeve band. The insignia of branch (metal or embroidery) will be worn in the center of the space formed by the lower curves of the knot and upper edge of the sleeve band.
- (a) *Colonel*. Five rows of braid.
- (b) *Lieutenant colonel*. Four rows of braid.
- (c) *Major*. Three rows of braid.
- (d) *Captain*. Two rows of braid.
- (e) *First lieutenant*. One row of braid.
- (f) *Second lieutenant*. Without knot. Insignia of branch to be worn in center, and 1 inch above sleeve band.
- (3) *Warrant officers*. Without sleeve band and knot. Insignia of grade to be worn on

sleeve, centered 4 inches from edge of sleeve.

11-6. Trousers (fig. 11-1). *a. Design*. Cut on the lines of civilian dress trousers with a high waist, without cuffs and hip pockets.

b. Ornamentation. On each outside seam from bottom of waistband to bottom of trouser leg.

(1) *General officers*. Two $\frac{1}{2}$ -inch stripes of two-vellum gold lace or of two-vellum gold color nylon or rayon braid, space $\frac{1}{2}$ -inch apart.

(2) *Other officers and warrant officers*. A stripe of two-vellum gold lace or of two-vellum gold color nylon or rayon braid $1\frac{1}{2}$ inches in width.

11-7. Vest. *a. Design*. Single-breasted, cut low, with rolling collar, pointed bottom, and fastened with three detachable extra small white buttons.

b. Optional. A black cummerbund may be worn in lieu of the vest.

11-8. Headgear. See paragraph 9-7.

11-9. Insignia. Only the following insignia are authorized for wear on the Army Blue Mess uniform:

a. Insignia of grade.

b. Insignia of branch to which assigned or detailed.

c. Distinctive insignia. Distinctive insignia are centered on lapels of jacket; upper edge of insignia is $\frac{5}{8}$ -inch below the notch. (Distinctive insignia is not worn if miniature decorations and medals are worn.)

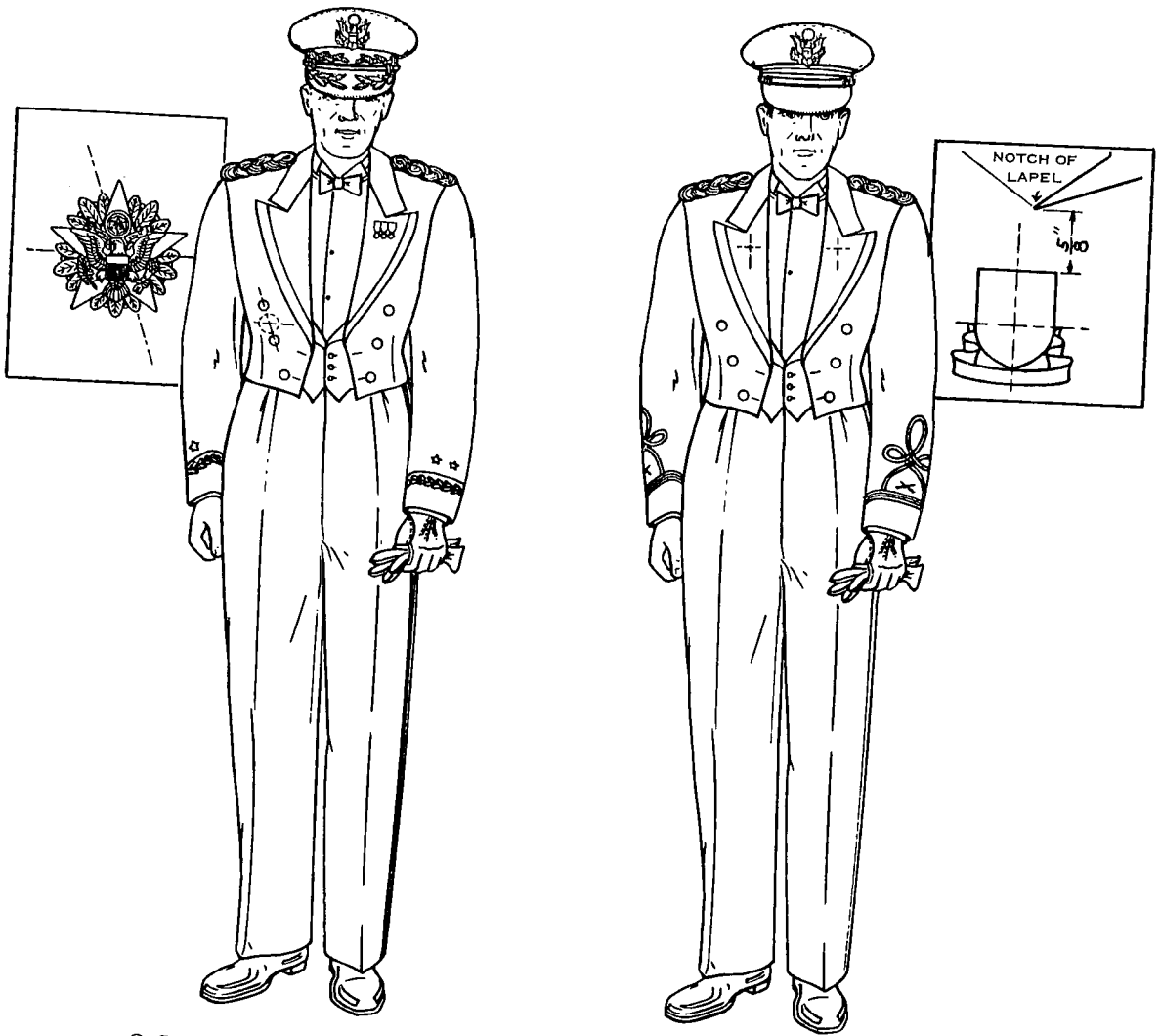

① General officers.

② Other than general officers.

Figure 11-1. Army Blue Mess uniform.

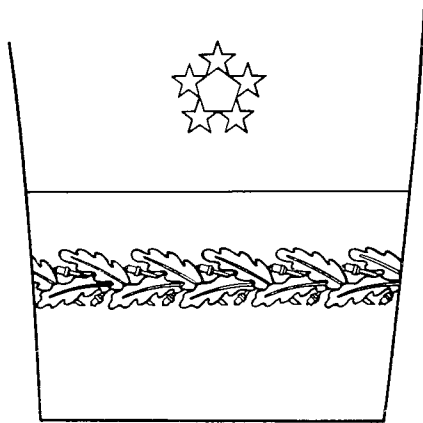

①

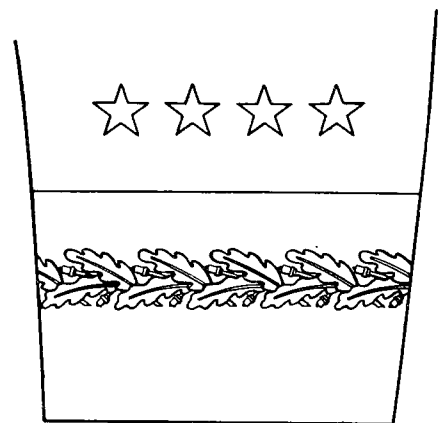

②

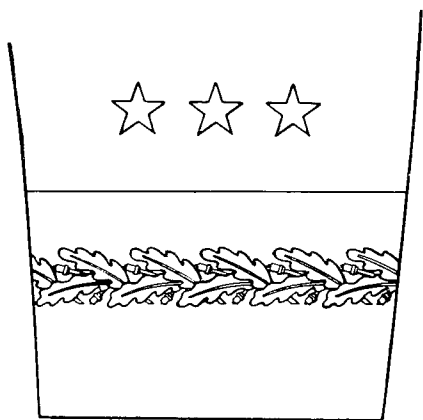

③

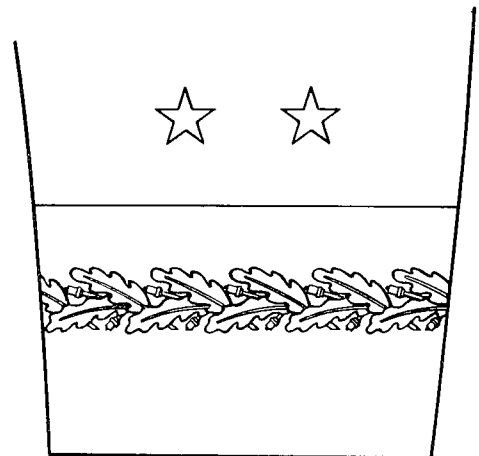

④

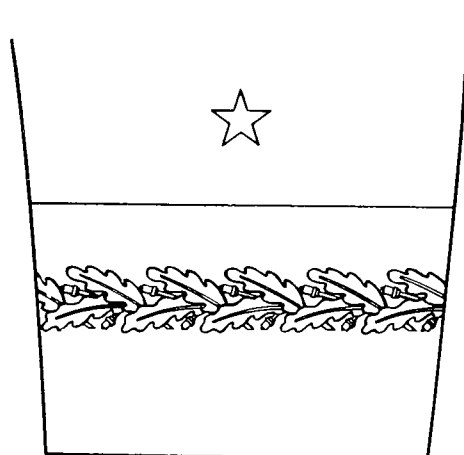

⑤

Figure 11-2. Sleeve ornamentation, general officers.

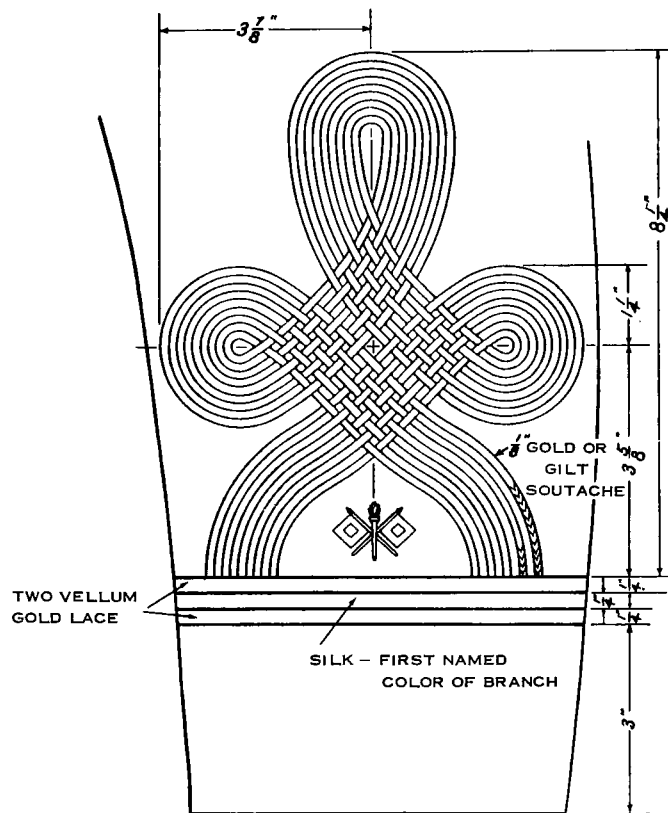
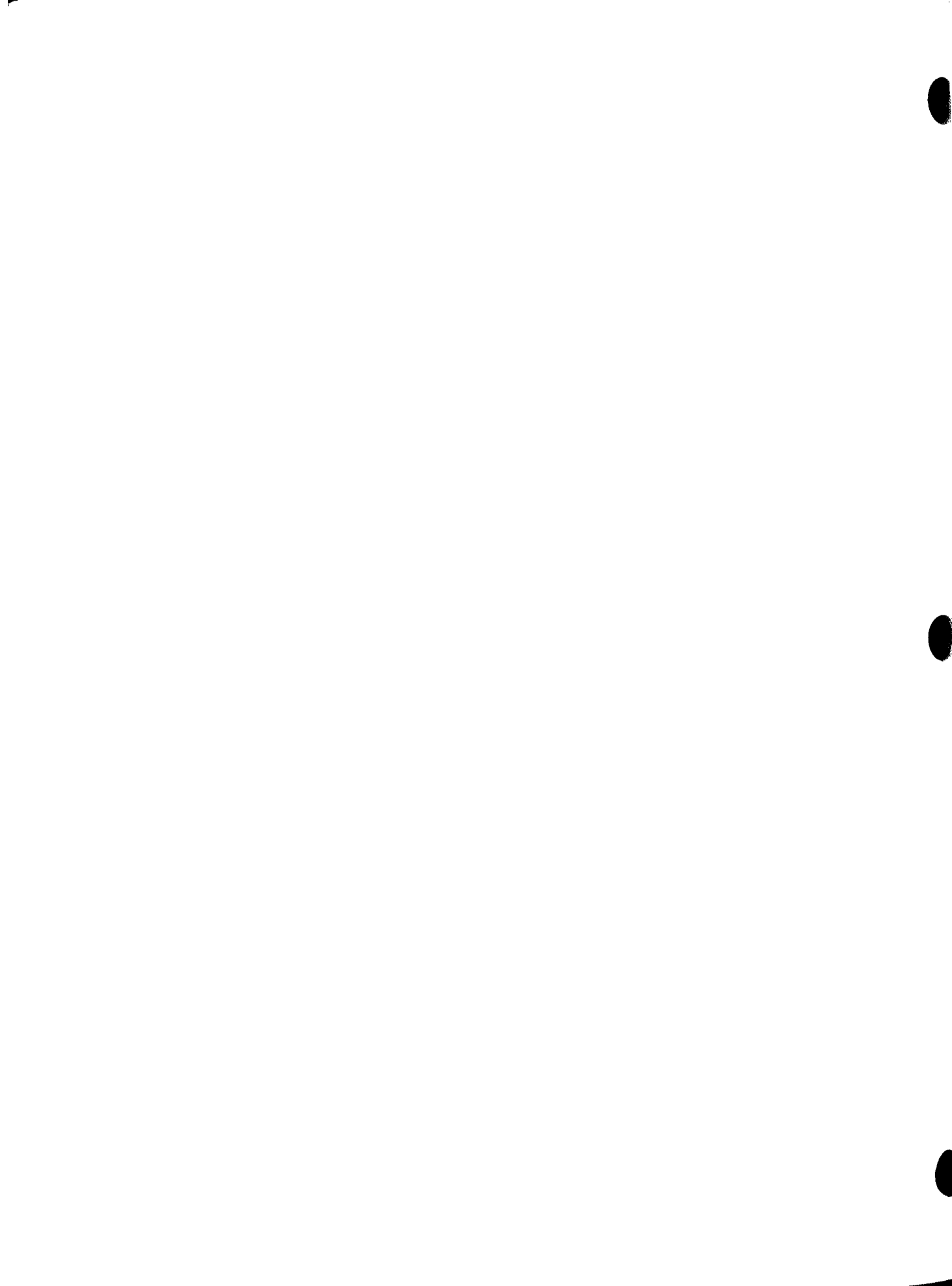

Figure 11-3. Sleeve ornamentation, other officers.



CHAPTER 12

ARMY EVENING DRESS UNIFORM

12-1. Authorization for wear. The Army Evening Dress uniform is authorized for optional wear by officers and warrant officers without regard to dates prescribed for wear of summer and winter service uniforms.

12-2. Composition. See appendix A.

12-3. Occasions for wear. *a.* Social functions of a general or official nature after retreat.

b. Private formal dinners and other private social functions after retreat.

12-4. Materials. *a. Coat and trousers.* Commercial type civilian evening dress material in suitable weights and weaves, shades blue-black or black.

b. Vest. White cotton pique or other conventional commercial type civilian white evening dress vest material.

12-5. Coat (fig. 12-1). *a. Design.* Of adopted design.

b. General description. A conventional commercial type civilian tail coat converted into a military garment by removing the commercial buttons and replacing the U.S. Army 30-line ($\frac{3}{4}$ -inch) coat buttons, three on each side and two at the top of the skirt at waistline. Coat is to be provided means of attaching shoulder knot.

c. Ornamentation, sleeve.

(1) *General officers* (fig. 11-2). Same as paragraph 11-5e(1).

(2) *Other officers and warrant officers* (figs. 12-2 and 12-3). Two inches from sleeve end, the Army design of ornamentation consisting of a separately attachable blue-black broadcloth background with a trefoil approximately 8 inches above top line of horizontal braid and $6\frac{1}{4}$ inches across horizontal loop, of $\frac{1}{4}$ -inch two-vellum gold bullion lace or gold color nylon or rayon embroidery based on a

horizontal strip of two-vellum gold color nylon or rayon embroidery or two-vellum gold bullion lace. To be placed on the outside center of both sleeves with the regulation insignia of grade embroidered $\frac{1}{4}$ -inch above horizontal braid. Colonel's eagles to look to the front of wearer. Captain's and lieutenant's bars to be placed with bars horizontal. Warrant officer's bars to be placed with bars vertical.

(a) *Field and company grade officers* (fig. 12-2). Horizontal braid 1 inch in width.

(b) *Warrant officers* (fig. 12-3). Horizontal braid $\frac{1}{4}$ -inch in width $2\frac{3}{4}$ inches from sleeve end with $\frac{1}{2}$ -inch separations 2 inches apart.

12-6. Trousers (fig. 12-1). *a. Design.* Cut on the lines of conventional civilian evening dress trousers, without cuffs.

b. Ornamentation. On each outside seam from bottom of waistband to bottom of trouser leg.

(1) *General officers.* Two $\frac{1}{2}$ -inch stripes of two-vellum gold lace or two-vellum gold color nylon or rayon braid, spaced $\frac{1}{2}$ -inch apart.

(2) *Other officers and warrant officers.* A stripe of two-vellum gold lace or gold color nylon or rayon braid $\frac{3}{4}$ -inch in width.

12-7. Vest, design. Single-breasted, cut low with rolling collar, with pointed bottom, and fastened with three extra-small detachable white buttons.

12-8. Headgear. See paragraph 9-7.

12-9. Insignia. The only insignia authorized for wear with the Army Evening Dress uniform is that prescribed in paragraph 12-5.

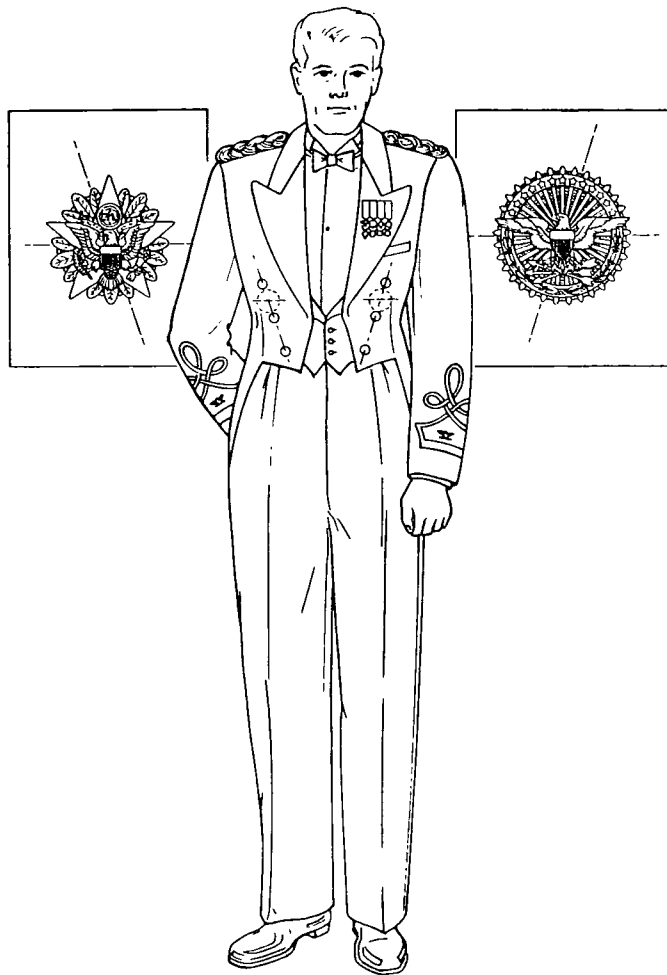

Figure 12-1. Army evening dress uniform.

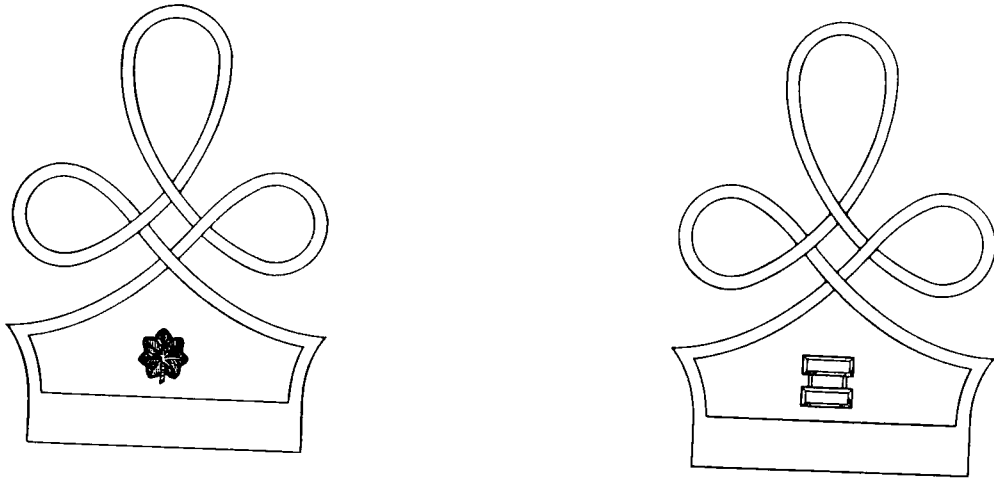

Figure 12-2. Sleeve ornamentation, officers.

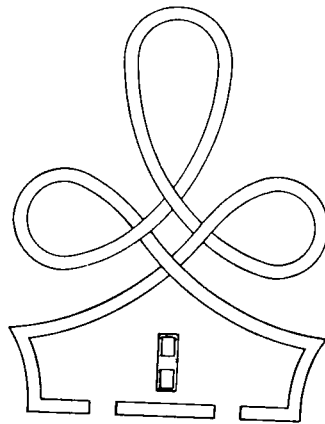

Figure 12-3. Sleeve ornamentation, warrant officers.



CHAPTER 13

ACCESSORIES

13-1. Belt, waist. *a. Description.*

(1) *Officers and warrant officers.*

- (a) A 1¼ inch web belt, black color, equipped with a plain-faced solid brass buckle, oval-shaped, 1⅞ inches long and 1⅜ inches wide.
- (b) For optional wear, a 1¼ inch woven elastic web belt, black color, equipped with a plain-faced solid brass buckle, oval or rectangular shaped 1⅞ inches long and 1⅜ inches wide.

(2) *Enlisted men.* A 1¼ inch web belt, black color, equipped with a plain-faced solid brass, oval-shaped, buckle, 1⅞ inches long and 1⅜ inches wide.

b. Wear. Tipped end of the belt will pass through buckle to the wearer's left, and will not extend beyond 2 inches of the buckle. Will be worn when the shirt is worn as an outer garment. Wear at other times is optional with the individual. (Suspenders of commercial pattern may be worn in lieu of belt, but must not be visible.)

13-2. Beret, wool, rifle green (fig. 13-1). *a. Material.* Knitted wool, moth resistant and water repellent treated, rifle green, Army shade 297.

b. Design. Of adopted design.

c. Wear.

- (1) Worn by all personnel assigned to Special Forces Units. May be worn under following conditions:
 - (a) With service uniform on or off duty.
 - (b) With field (tropical combat) uniform when wear of steel helmet is not required or appropriate.
 - (c) With work uniform except cooks and mechanics.
- (2) Beret will not be worn with Army Blue, White, White Mess, Blue Mess or Evening Dress uniforms.
- (3) It is the policy of the Department of the Army that major commanders not deny Special Forces personnel the privilege of wearing the beret.

d. Manner of wear. Headband (edge binding) straight across forehead, one inch above eyebrows. Top of beret draped over right ear; and stiffener for affixing insignia positioned over left eye. Ends of adjusting ribbon will be cut off and the ribbon knot secured inside the edge binding at rear of head.

e. Insignia. Only distinctive insignia for enlisted personnel or insignia of grade for officers and warrant officers will be worn. Insignia will be centered on stiffener above left eye.

f. Flash. Will be in accordance with paragraph 14-18.

13-3. Buttons. *a.* Gold plated or gold color buttons on coat and cap of uniforms for all personnel, except as prescribed in *b* below, will be as shown in ①, figure 13-2.

b. Gold plated or gold color buttons on coat and cap of service uniforms for officers of the Corps of Engineers will be as shown in ②, figure 13-2.

Note. Anodized aluminum buttons (shiny white gold appearance) are authorized for optional purchase and wear in lieu of the gold plated or gold colored buttons. Size and configuration must conform to the standard button. Anodized aluminum buttons will not be mixed with standard buttons on the complete uniform coat.

c. Buttons on the overcoat for all personnel will be of plastic conforming in color to material of coat (③, fig. 13-2).

d. Sizes are prescribed in specifications for articles of clothing.

13-4. Cape, blue (fig. 13-3). *a. Material.*

- (1) Wool baratheas, 14 or 18 ounce weight, Army shade 150.
- (2) Wool gabardine, 14.5 ounce weight, Army shade 150.
- (3) Wool elastique, 16 or 18 ounce weight, Army shade 150.

b. Design. To be of such length as to cover the skirt of the evening dress coat but to reach no lower than a point 2 inches below the knee.

c. Lining.

- (1) *General officers.* Dark blue rayon or ace-

tate, or other synthetic fabric with satin face and wool nap back, 5 ounce minimum weight.

(2) *Other officers.* Same as (1) above in cloth of the first named color of the officer's basic branch.

(3) *Warrant officers.* Same as (1) above, brown cloth.

d. Wear.

(1) With evening dress uniform.

(2) Optional with the Army Blue and Army Blue Mess uniforms in lieu of the overcoat, Army Green, or the overcoat, taupe.

13-5. Collar, white. *a. Material.* Plain white cotton material without stripe or figure.

b. Design.

(1) Full dress (wing).

(2) Turned down, semisoft or stiff type.

13-6. Cover, cap, rain. Authorized for optional purchase and wear by officers, warrant officers, and enlisted men with the service cap and the raincoat in inclement weather.

a. Taupe, shade 179, with or without visor protector for wear with the taupe raincoat.

b. Transparent plastic with or without visor protector for wear with the green/taupe raincoat.

c. Army Green 274 cotton and nylon quarpel with or without visor protector for wear with the green raincoat only until 30 June 1971.

13-7. Gloves. Gloves will be worn whenever overcoat is worn. Color of gloves will be determined by uniform being worn. See appendix A.

a. Black.

(1) *Material.* Leather.

(2) *Description.* Glove as issued or commercial type, lined or unlined, snap fastener or pull-on glove.

(3) *Wear.*

(a) On duty.

(b) Off duty.

(c) In formation when authorized.

b. White.

(1) *Material.* White kid, silk, cotton, or other material.

(2) *Design.* Commercial design.

Note. White gloves may be worn with the service uniform when prescribed by the commanding officer on occasions of ceremony.

13-8. Hat, service (campaign) (fig. 13-4). *a. Material.* Fur felt, olive drab.

b. Design. Of adopted design.

c. Wear.

(1) By Army drill sergeants under the following conditions:

(a) Noncommissioned officers designated as drill sergeants and assigned to basic combat platoons in U.S. Army training centers as principal trainer or assistant trainer, i.e., senior drill sergeant or drill sergeant, respectively.

(b) First sergeants who are assigned to basic combat training companies, who have graduated from a drill sergeant school, and who have performed satisfactorily in a drill sergeant assignment prior to appointment as a first sergeant.

(c) Noncommissioned officer faculty members of a drill sergeant school who are drill sergeant school graduates and who are actively engaged in instructing drill sergeants classes.

(2) A noncommissioned officer, upon release from assignments cited in (1) above, will no longer be authorized to wear the service hat.

d. Proper wear position. The black leather strap, issued with the hat, will be threaded through the appropriate eyelets in the brim of the hat so that the strap goes around the front of the hat and the buckle is fastened and centered at the back of the wearer's head. The running end of the strap will be to the wearer's left. The hat will be worn without noticeable tilt to the front, rear, or either side, and to permit the brim of the hat to be as nearly level in all directions as possible. No modifications in the shape of the hat are authorized.

e. Insignia. The insignia authorized in paragraph 14-3b(3) for wear on the enlisted man's service cap will be worn in the front eyelet of the service hat. The plastic disk described in paragraph 14-47c will not be worn on the service hat.

13-9. Laces, boot and shoe. Laces will be of same color as boot or shoe.

13-10. Necktie. *a. Four-in-hand, black.*

(1) *Material.* Tropical worsted or other similar type woven fabrics, approximately 8 ounces in weight. Knitted fabric is authorized on an optional basis.

(2) *Design.* Of adopted design. A pretied snap-on necktie is authorized on an optional basis.

b. Bow, black.

- (1) *Material.* Black silk or rayon without stripe of figure.
- (2) *Design.* Commercial type, bow with square ends.
- (3) *Wear.* Required to be worn with Army White Mess and Army Blue Mess uniforms. Authorized for optional wear with Army Blue and Army White uniforms.

c. Bow, white.

- (1) *Material.* Plain white silk or rayon, or material matching shirt, without stripe or figures.
- (2) *Design.* Conventional civilian full dress type.
- (3) *Wear.* Required to be worn with Army evening dress uniform.

13-11. Overcoat. *a. Wool gabardine, Army Green shade 44 (fig. 13-5).*

- (1) *Material.* Wool gabardine, 14.5 ounce weight, Army Green shade 44.
- (2) *Design.* Of adopted design.
- (3) *Wear.* Officers, warrant officers, and enlisted men. May be worn with civilian clothing when insignia of grade is removed.

b. Cotton sateen, olive green, Army shade 107.

- (1) *Material.* Cotton sateen, 9 ounce weight, wind resistant and water repellent, olive green, Army shade 107.
- (2) *Design.* Of adopted design.
- (3) *Wear.* By enlisted men.

Note. This overcoat becomes obsolete 1 July 1970.

c. Wool gabardine, taupe, Army shade 79 (fig. 13-6).

- (1) *Material.* Wool gabardine, 14.5 ounce weight, taupe, Army shade 79.
- (2) *Design.* Of adopted design.
- (3) *Wear.*
 - (a) Officers and warrant officers.
 - (b) Enlisted men. Optional for off-duty wear with the Army Green and Army Blue uniform.
 - (c) May be worn with civilian clothing when insignia of grade is removed.

Note. This overcoat becomes obsolete 1 July 1970.

13-12. Overshoes, black (fig. 13-7). *a. Material.* Rubber or synthetic.*b. Design.* Commercial, with tongue.

c. Wear. (Optionally) By officers, warrant officers, and enlisted men, with low quarter shoes, when not in formation.

13-13. Raincoat (fig. 13-8). *a. Army Green shade 274.*

- (1) *Material.* Cotton/nylon oxford, 5 ounce weight, water repellent treated, Army Green shade 274.
- (2) *Design.* Of adopted design.
- (3) *Wear.* By officers, warrant officers, and enlisted men with service and dress uniforms. It may be worn with uniforms other than service or dress only in those instances when authorized by commanders. May be worn with civilian clothing by enlisted personnel, and by officers and warrant officers when insignia of grade is removed.

b. Taupe, Army shade 179.

- (1) *Material.* Nylon, 1.6 ounce weight, taupe, Army shade 179.
- (2) *Design.* Of adopted design.
- (3) *Wear.*
 - (a) Same as a(3) above.
 - (b) May be worn with civilian clothing when insignia of grade is removed.

Note. This raincoat becomes obsolete 1 July 1971.

13-14. Scarf. *a. Army Green.*

- (1) *Material.*
 - (a) Wool, Army Green shade 44.
 - (b) Silk or rayon, Army Green shade 279.
- (2) *Design.* Commercial design, approximately 12 by 52 inches.
- (3) *Wear.* Authorized for wear by officers, warrant officers, and enlisted men with the overcoat when it is worn with the Army Green uniform.

b. Olive drab.

- (1) *Material.* Wool, olive drab, Army shade 30A.
- (2) *Design.* Of adopted design.
- (3) *Wear.* Authorized for wear by officers, warrant officers, and enlisted men with the overcoat when it is worn with field clothing.

c. White.

- (1) *Material.* Rayon, silk, or wool, bleached white.
- (2) *Design.* Commercial design.

(3) *Wear.*

(a) *Officers and warrant officers.* With the Army Green or taupe overcoat when the Army Blue or Army Blue Mess uniform is worn.

(b) *Enlisted men.* With the Army Green or taupe overcoat when the Army Blue uniform is worn.

13-15. Shirt. *a. Shade 446, long sleeve.*

(1) *Material.* Polyester and cotton broadcloth, 2.8 to 3.2 ounce weight, tan, Army shade 446.

(2) *Design.* Of adopted design.

(3) *Wear.* See appendix A.

b. Shade 446, short sleeve. Authorized for optional purchase and wear by officers, warrant officers and enlisted men with the Army Green coat and trousers.

c. Shade 46.

(1) *Material.* Cotton poplin, 3.5 to 4 ounce weight, tan Army shade 46.

(2) *Design.* Of adopted design.

(3) *Wear.* See appendix A.

Note. Shirts of nylon, nylon blend, or similar suitable synthetic plain weave fabrics in Army shades 46 or 446, which present a military appearance comparable to the specified shirts, may be worn by all personnel when not in formation.

d. White.

(1) *Material.* White, plain weave cotton, synthetic or blend, without stripe or figure.

(2) *Design.* Of commercial design with barrel or French cuffs and standard turn-down collar. If shirt with detachable collar is worn, collar will be as prescribed in paragraph 13-5.

(3) *Wear.* See appendix A.

e. White, evening dress.

(1) *Material.* White cotton, synthetic or blend.

(2) *Design.* Semiformal, civilian dress-type shirt with soft bosom, such as pleated, French cuffs, with attached or detachable turndown collar.

(3) *Wear.* See appendix A.

f. White, full dress.

(1) *Material.* White cotton, synthetic or blend.

(2) *Design.* Formal, civilian full-dress type, with stiff bosom such as plain starched or pique, French cuffs, with attached or detachable wing collar.

(3) *Wear.* See appendix A.

13-16. Shoes, low quarter, black (fig. 13-9).

a. Material. Leather; Poromeric material with leather finish is authorized for optional wear.

b. Design. Of adopted design. Plain toe, blucher oxford, chukka boot, or similar commercial design is also authorized.

c. Wear. By officers, warrant officers, and enlisted men.

13-17. Shoulder knots. *a. Material.* Of gold bullion cord or gold color nylon or rayon cord $\frac{1}{4}$ -inch in diameter.

b. Design. The knot to be formed of four plaits of three-cord and rounded at the top; a small 20-line ($\frac{1}{2}$ -inch) gold regulation button in the upper end of the knot. Knot to be not more than $5\frac{1}{2}$ inches in length and $2\frac{1}{2}$ inches in width, conforming to the shoulder, to be stiffened on the underside with a flexible backing covered with dark blue or black cloth; to have attached to the strap a suitable attachment for fastening to the shoulder of coat.

c. Wear. See appendix A.

13-18. Socks, black. *a. Material.* Cotton or cotton/nylon, rib, black, elastic top or stretch type.

b. Design. Of adopted design.

c. Wear. By officers, warrant officers, and enlisted men.

13-19. Studs and cuff links. *a. Design.* Of commercial design.

b. Color.

(1) With the Army Evening Dress uniform. Plain white (such as white mother-of-pearl) with or without rims of platinum or white gold.

(2) With the Army Blue Mess and Army White Mess uniforms. Gold or gold color metal, round, plain face; cuff links to be $\frac{1}{2}$ - to $\frac{3}{4}$ -inch in diameter, of post or link type; studs to be $\frac{1}{4}$ - to $\frac{3}{8}$ -inch in diameter. (Personnel now possessing white cuff links and studs may continue to wear them until replacement is required.)

(3) With the Army Blue and Army White uniforms. When worn, cuff links will be of plain gold or gold color metal as described in (2) above.

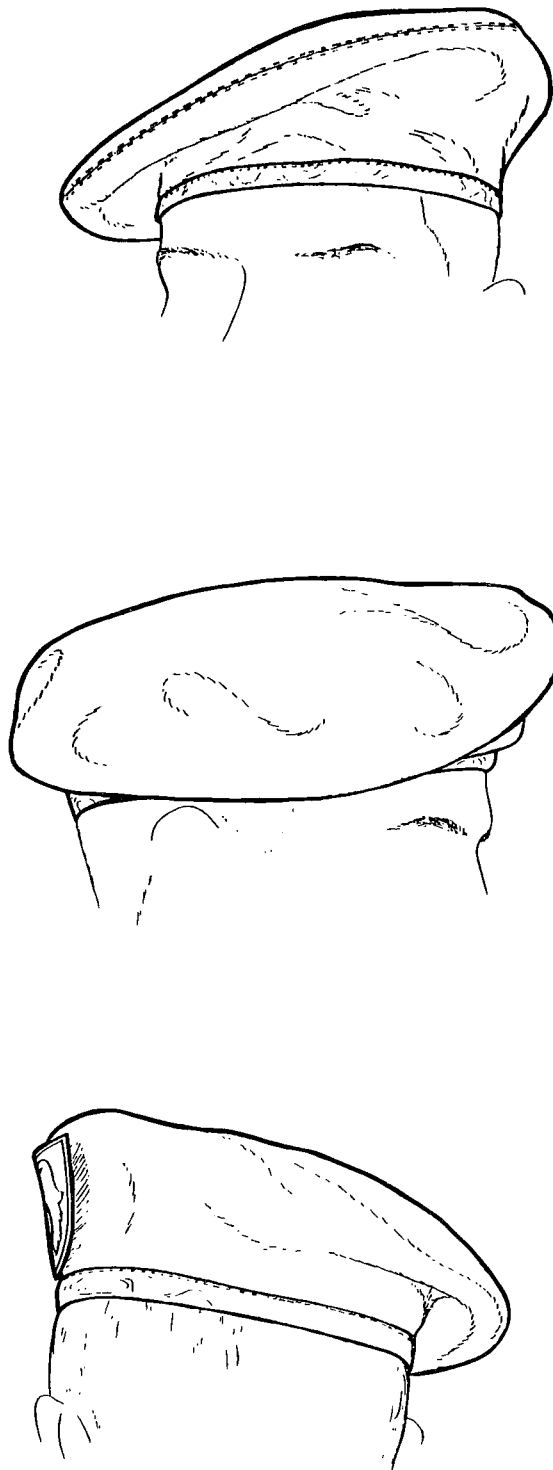

Figure 13-1. Beret, wool.

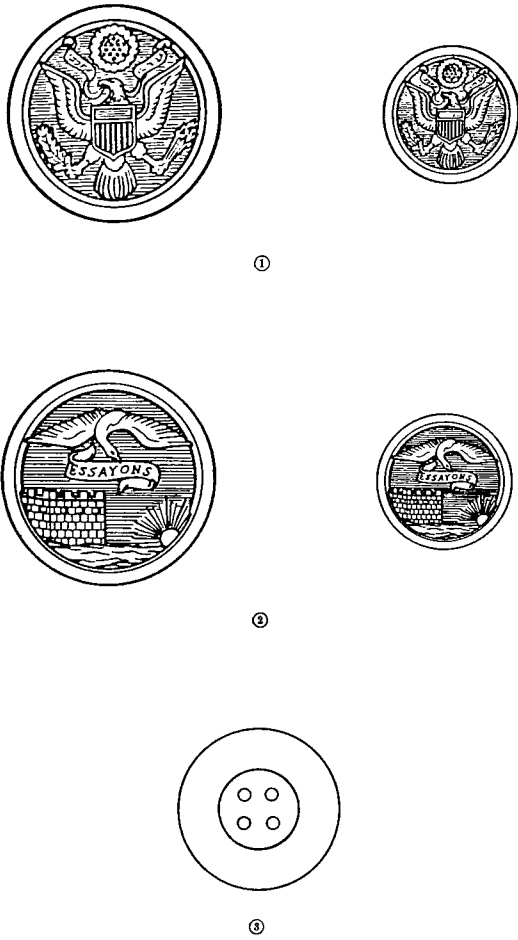

Figure 13-2. Buttons.

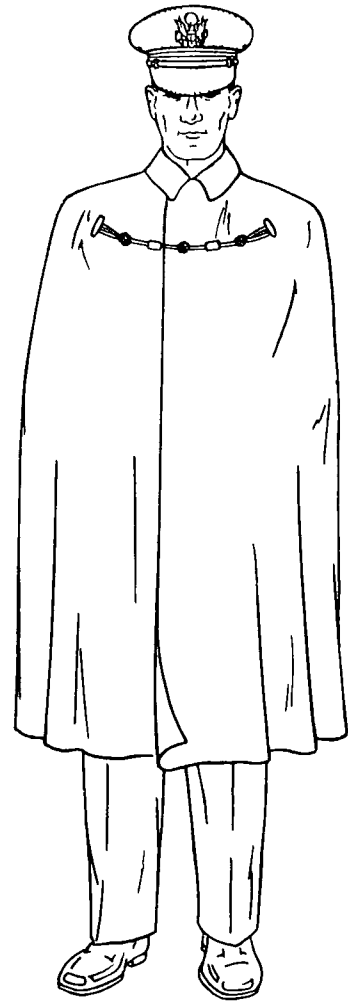

Figure 13-3. Cape, blue.

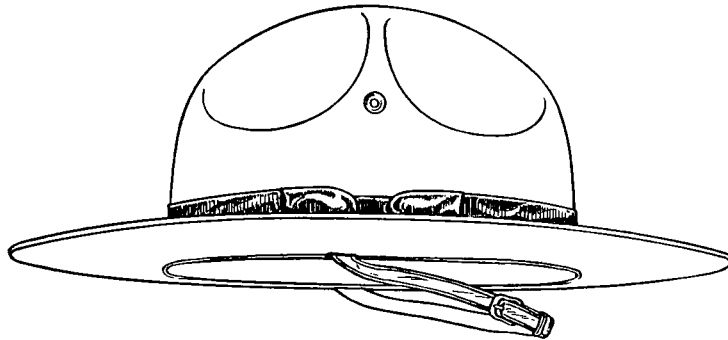
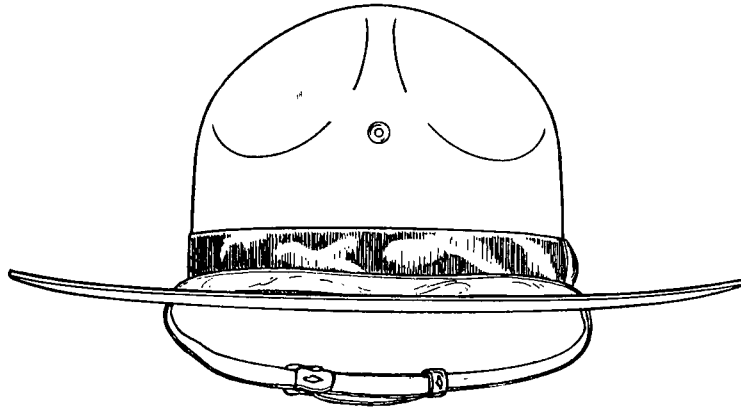

Figure 13-4. Hat, service (campaign).

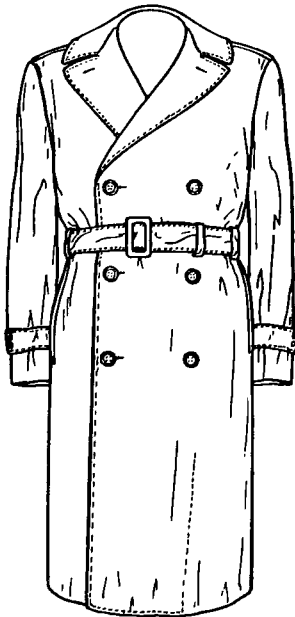

Figure 13-5. Overcoat, wool, gabardine, Army Green.

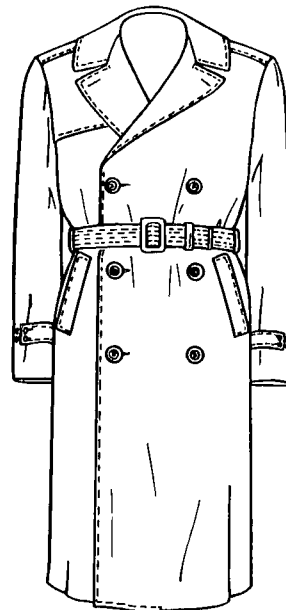

Figure 13-6. Overcoat, wool, gabardine, Taupe.

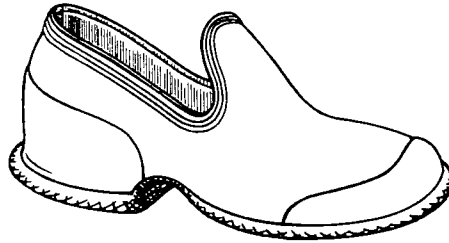

Figure 13-7. Overshoes.

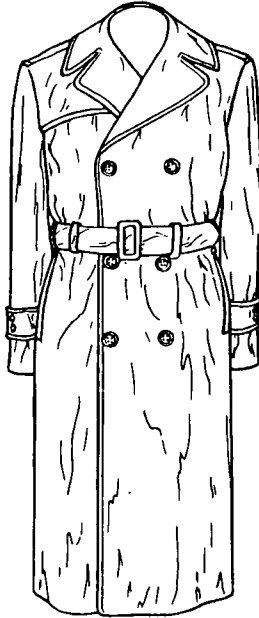

Figure 13-8. Raincoat.

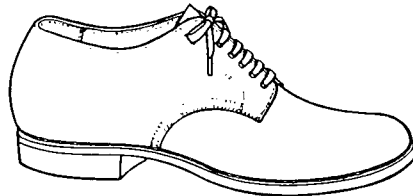

Figure 13-9. Shoes, low quarter.

CHAPTER 14

INSIGNIA AND ACCOUTERMENTS

14-1. Use. *a.* The insignia worn by military personnel designate the following:

- (1) Grade.
- (2) Branch.
- (3) Capacity or duty assignment.
- (4) Prior Army service.

b. Insignia other than items specifically authorized by this regulation will not be worn on the uniform, except that—

- (1) Headquarters, Department of the Army may grant specific authorization therefor.
- (2) The Chief of Staff, former chiefs of staff, and Generals of the Army may prescribe their own insignia.

c. Members of bands, honor guards, color guards, and similar details will wear the prescribed uniform without nonregulation accouterments. The only exception will be for those units authorized to wear distinctive uniforms by TA 50-906.

14-2. General description. *a. Material.* Insignia will meet the approved material specifications. Officers and warrant officers may wear, on an optional basis, insignia of gold or silver color embroidery in lieu of metal insignia of grade and collar and lapel insignia.

- (1) *Insignia of grade.*
 - (a) *Officers and warrant officers.* Appropriate color metal or embroidery.
 - (b) *Enlisted personnel.* Embroidery.
- (2) *Collar and lapel insignia.*
 - (a) *Officers and warrant officers.* Appropriate color metal or embroidery. (The "U.S." and branch insignia worn on the collar and lapel will be of the same material.)
 - (b) *Enlisted personnel.* Gold color metal.

b. Design. All requests for insignia designs will be submitted to The Institute of Heraldry, U.S. Army, Cameron Station, Alexandria, Va., 22314. Samples of approved designs will be retained by that office.

- (1) In creating or selecting a design, consideration must be given to all other in-

signia which may be authorized for wear by the individual in order that the collective insignia will enhance the attractiveness of the uniform and contribute to the unit or individual morale.

- (2) Requirements in the interest of good visibility are—
 - (a) Simplicity.
 - (b) Proper color combinations.
 - (c) Minimum of detail.
- (3) Insignia which involve heads or direction will be made to face to the right or front.

c. Attachment. Insignia will be attached to the uniform in such manner that they will rest firmly without turning. Embroidered insignia will be attached to the uniform only by sewing. Insignia which are sewn to the uniform will be attached in such a manner that the stitching will blend into the background, making it unobtrusive.

14-3. Headgear ornamentation and insignia.

a. Cap, garrison.

- (1) Garrison cap braid refers to piping used for additional identification purposes. Braid will be secured to the top edge of the curtain of the garrison cap.
 - (a) *General officers.* Cord edge braid of gold bullion or gold color rayon.
 - (b) *All other officers.* Cord edge braid of gold bullion or gold color silk with black rayon or black silk intermixed.
 - (c) *Warrant officers.* Cord edge of silver bullion or silver color rayon or silver color silk with black rayon or black silk intermixed.
 - (d) *Enlisted men.* Cord edge braid matching the cap, Army Green, shade 344.
- (2) The following insignia are worn on the garrison cap:
 - (a) *Officers and warrant officers.*
 1. Insignia of grade centered on the left curtain (para 14-5) (fig. 14-1).

2. Optional for those assigned to airborne organizations; the approved "Airborne" cap insignia centered on the right curtain (para 14-19c).

(b) *Enlisted men.*

1. Approved unit (distinctive) insignia centered on the left curtain (para 14-19a) (fig. 14-1).
2. Optional for those assigned to airborne organizations; the approved "Airborne" cap insignia in lieu of the unit insignia (para 14-19c).

b. *Cap, service.* Insignia will be worn on the cap, service, secured through the front eyelet provided thereon.

- (1) *All officers.* The coat of arms of the United States $2\frac{3}{8}$ inches in height of gold plated metal (①, fig. 14-2).
- (2) *Warrant officers.* An eagle rising with wings displayed standing on a bundle of two arrows, all inclosed in a wreath. Insignia to be $1\frac{1}{2}$ inches in height of gold plated metal (②, fig. 14-2).
- (3) *Enlisted personnel.* A plain disk $1\frac{1}{2}$ inches in diameter, superimposed thereon the coat of arms of the United States, all of gold color metal (③, fig. 14-2).

c. *Helmet and helmet liner.* Only the insignia prescribed below will be placed on the helmet or helmet liner (fig. 14-3). (Except for special safety or training requirements, the only authorized color for helmets and helmet liners is Munsell Color Company shade 10Y 3/3.)

- (1) *All officers (except chaplains) and all warrant officers.*
 - (a) Insignia of grade, of the prescribed size and color, as shown in figure 14-3.
 - (b) Optional replica of authorized distinctive and/or shoulder sleeve insignia, either painted or decalcomania, placed in positions approximately over the ears. When both insignia are worn, the shoulder sleeve insignia is placed on the left side; the distinctive insignia is placed on the right side of the helmet or helmet liner.
- (2) *Enlisted personnel.*
 - (a) Insignia of grade without background, of black color, 2 inches in width, as shown in ⑤, figure 14-3.

- (b) Authorized distinctive and/or shoulder sleeve insignia. Same as (1) (b) above.
- (3) *Chaplains.* The appropriate chaplain insignia (no insignia of grade), of the prescribed size and color, as shown in ④, figure 14-3.

(4) *All military police personnel* (fig. 14-4).

(a) The letters "MP" on the helmet or helmet liner as shown in figure 14-4.

(b) A painted band generally parallel to the edge and following the contour of the helmet or helmet liner as shown in figure 4. The band to be alined with the letters "MP" and in the following colors:

1. *Division units.* $1\frac{1}{4}$ -inch red band.
2. *Corps units.* $\frac{5}{8}$ -inch blue stripe above a $\frac{5}{8}$ -inch white stripe.
3. *Army units.* $\frac{5}{8}$ -inch white stripe above a $\frac{5}{8}$ -inch red stripe.
4. *Other Military Police units including school troops.* $1\frac{1}{4}$ -inch white band.

(c) Unit numerical designation and unit distinctive insignia to be optional, but when so ordered to be placed on helmet or helmet liner approximately over the wearer's ears, centered on the colored band. Neither the numerical designation nor the distinctive insignia to exceed 3 inches in height or width. The numerical designation to be placed on the left side, and the distinctive insignia on the right of the helmet liner.

(d) Insignia of grade.

1. *Officers and warrant officers.* Insignia of grade of the prescribed size and color placed as shown in ①, figure 14-4.
2. *Enlisted men.* The insignia of grade without background, of black color, placed as shown in ②, figure 14-4.

d. *Wearing insignia on special headgear.* When necessary for purposes of identification, commanders are authorized to direct the wearing of insignia of grade only, appropriately painted or attached to special headgear.

e. *Wearing insignia on utility cap.* Commanders are authorized to direct the wearing of insignia of grade by officers and distinctive insignia by enlisted personnel on the utility cap.

14-4. "U.S." insignia. *a. Officers and warrant officers.*

- (1) *Description.* Block letters "U.S." of gold color, $\frac{7}{16}$ -inch in height, each letter followed by a period (①, fig. 14-5).
- (2) *How worn.* On both collars of the coat as shown in figure 14-6.

b. Enlisted personnel.

- (1) *Description.* Block letters "U.S." $\frac{1}{2}$ -inch in height on a 1-inch disk, all of gold metal (②, fig. 14-5). Multiple piece insignia are authorized on an optional basis. Such items will not be furnished from appropriate funds.
- (2) *How worn.*
 - (a) On the right collar of coat as shown in ③, figure 14-6. For exceptions, see (c) below.
 - (b) On right collar of shirt (fig. 14-7).
 - (c) On both collars of the coat and on both collar ends of shirt—by male enlisted personnel, prior to completion of basic training, who are not assigned to a branch unit.

14-5. Insignia of grade for officers. *a. General of the Army* (①, fig. 14-8).

(1) *Description.*

- (a) Five sterling silver five-pointed stars, each star $\frac{3}{8}$ -inch in diameter, fastened together in a circle, inner points touching, the surface of the stars to be smooth, center ridges raised in "V" section, ridges and points rounded.
- (b) *Coat of arms of the United States.* Gold plated metal $\frac{7}{8}$ -inch in height, with the shield and crest enameled.

(2) *How worn.*

- (a) Stars and coat of arms on shoulder loops of coat, raincoat, overcoat, and jacket as shown in ②, figure 14-8.
- (b) Stars on both ends of shirt collar when worn as an outer garment, placed with vertical center line at angles to top edge of collar, and visually centered; the front edge of the insignia 1 inch from front edge of collar (③, fig. 14-8).
- (c) On garrison cap on left side as shown in ④, figure 14-8.
- (d) On helmet and helmet liner as shown in figure 14-3.

b. All other general officers.

- (1) *Description.* Sterling silver five-pointed stars, each star 1-inch in diameter, center ridges raised in "V" sections, ridges and points sharp; or sterling silver stars (miniatures), each $\frac{5}{8}$ -inch in diameter. (Miniatures may be worn only on shirt and garrison cap; 2 or more stars must be placed on a bar.)
 - (a) *General.* Four sterling silver stars (①, fig. 14-9).
 - (b) *Lieutenant general.* Three sterling silver stars (②, fig. 14-9).
 - (c) *Major general.* Two sterling silver stars (③, fig. 14-9).
 - (d) *Brigadier general.* One sterling silver star (④, fig. 14-9).

(2) *How worn.*

- (a) *On shoulder loops of coats, raincoats, and overcoats.*
 1. *General* (⑦, fig. 14-9).
 2. *Lieutenant general* (⑧, fig. 14-9).
 3. *Major general* (⑨, fig. 14-9).
 4. *Brigadier general* (⑩, fig. 14-9).

Note. The requirement for equidistant spacing (as shown in ⑦ through ⑩, fig. 14-9) precludes the wearing of stars joined by a bar on the coats of uniforms. However, full size stars joined by a bar may be worn on overcoats, raincoats, and olive green coats, i.e. field jackets.

- (b) *On shirt when worn as an outer garment.* On both ends of the collar, placed with the horizontal line of the stars parallel to the top edge of the collar, and visually centered; front edge of the insignia 1 inch from front edge of collar (⑤, fig. 14-9). General officers appointed in or assigned to duty with technical or administrative branches are authorized to wear the appropriate insignia of branch or service on the left collar in lieu of the insignia of grade.
 - (c) *On garrison cap.* On the left side as shown in ⑥, figure 14-9.
 - (d) *On helmet and helmet liner.* As shown in figure 14-3.

c. Colonel (fig. 14-10).

- (1) *Description.* A sterling silver spread eagle $\frac{3}{4}$ -inch in height, $1\frac{1}{2}$ inches between tips of wings. (Insignia is to be made in pairs

in order that, when worn, the head of the eagle and laurel branch will face to the front.)

(2) *How worn.*

- (a) *On shoulder loops of coat, raincoat, and overcoat.* The eagle head toward the neck, beak to the front (fig. 14-10).
- (b) *On right collar of a shirt when worn as outer garment.* The wings of the eagle are parallel to the top edge of the collar, beak to the front of wearer, visually centered; the front edge of the wing tip 1 inch from front edge of collar (fig. 14-10).
- (c) *On garrison cap.* On the left side, the head of the eagle facing to the front (fig. 14-10).
- (d) *On the helmet and helmet liner.* Centered on the front, head of the eagle facing to the wearer's right (fig. 14-3).

d. *Lieutenant colonel* (fig. 14-11).

- (1) *Description.* A sterling silver oak leaf, with irregular surface, 1-inch in height and 1-inch in width.
- (2) *How worn.*
 - (a) *On shoulder loops of coat, raincoat, and overcoat.* As shown in figure 14-11.
 - (b) *On right collar of a shirt when worn as an outer garment.* The stem of leaf down, placed with vertical center line parallel to front edge of collar, and visually centered, the front edge of the insignia 1 inch from front edge of collar (fig. 14-11).
 - (c) *On garrison cap.* On the left side, stem of leaf down (fig. 14-11).
 - (d) *On helmet and helmet liner.* Centered on the front, leaf worn with stem down (fig. 14-3).

e. *Major* (fig. 14-11).

- (1) *Description.* A gold plated metal oak leaf, with irregular surface, 1-inch in height and 1-inch in width.
- (2) *How worn.*
 - (a) *On shoulder loops of coat, raincoat, and overcoat.* As shown in figure 14-11.
 - (b) *On right collar of a shirt when worn as an outer garment.* Same as d(2)(b) above.

(c) *On garrison cap.* Same as d(2)(c) above.

(d) *On helmet and helmet liner.* Same as d(2)(d) above

f. *Captain* (fig. 14-12).

- (1) *Description.* Two sterling silver bars each $\frac{3}{8}$ -inch in width, 1-inch in length with smooth surface. Bars to be $\frac{1}{4}$ -inch apart.
- (2) *How worn.*
 - (a) *On shoulder loops of coat, raincoat, and overcoat.* As shown in figure 14-12.
 - (b) *On right collar of a shirt when worn as an outer garment.* Placed with the long edges of the bars parallel to the front edge of the collar and visually centered; the front edge of the insignia 1 inch from edge of collar (fig. 14-12).
 - (c) *On garrison cap.* On the left side (fig. 14-12).
 - (d) *On helmet and helmet liner* (fig. 14-3).

g. *First lieutenant* (fig. 14-13).

- (1) *Description.* One sterling silver bar $\frac{3}{8}$ -inch in width, 1-inch in length, with smooth surface.
- (2) *How worn.*
 - (a) *On shoulder loops of coat, raincoat, and overcoat.* As shown in figure 14-13.
 - (b) *On right collar of a shirt when worn as outer garment.* Placed with the long edges of the bars parallel to the front of edge of the collar, and visually centered; the front edge of the insignia 1 inch from edge of collar (fig. 14-13).
 - (c) *On garrison cap.* On the left side, bar is perpendicular to bottom edge of cap (fig. 14-13).
 - (d) *On helmet and helmet liner.* Centered on the front, bar perpendicular to the bottom edge (fig. 14-3).

h. *Second lieutenant* (fig. 14-13).

- (1) *Description.* One gold plated metal bar $\frac{3}{8}$ -inch in width, 1-inch in length, with smooth surface.
- (2) *How worn.*
 - (a) *On shoulder loops of coat, raincoat, and overcoat.* As shown in figure 14-13.
 - (b) *On right collar of a shirt when worn as an outer garment.* Same as g(2)(b) above (fig. 14-13).

(c) *On garrison cap.* Same as *g(2)(c)* above.

(d) *On helmet and helmet liner.* Same as *g(2)(d)* above.

14-6. Insignia of grade for warrant officers.

a. Description. One bar $\frac{3}{8}$ -inch in width and $1\frac{1}{8}$ inches in length (fig. 14-14).

(1) *Warrant officer, grade 1* (fig. 14-14).

Gold plated metal bar with two brown enamel bands.

(2) *Warrant officer, grade 2* (fig. 14-14).

Gold plated metal bar with three brown enamel bands.

(3) *Warrant officer, grade 3* (fig. 14-14).

Sterling silver bar with two brown enamel bands.

(4) *Warrant officer, grade 4* (fig. 14-14).

Sterling silver bar with three brown enamel bands.

b. How worn.

(1) *On shoulder loops of coat, raincoat, and overcoat.* As shown in figure 14-14.

(2) *On right collar of a shirt when worn as an outer garment.* Same as paragraph 14-5*g(2)(b)* (fig. 14-14).

(3) *On garrison cap.* On the left side, bar perpendicular to the bottom edge of the cap (fig. 14-14).

(4) *On helmet and helmet liner.* Centered on the front, bar perpendicular to the bottom edge (fig. 14-3).

14-7. Insignia for officer candidates. *a. Description.* Block letters "O.C.S." of gold plated metal $\frac{7}{16}$ -inch in height, each letter followed by a period (①, fig. 14-15).

b. How worn. On both lapels of coat as shown in ②, figure 14-15. On both collars of shirt placed with horizontal line parallel to the top edge of the collar, and visually centered; the front edge of the insignia 1 inch from front edge of collar (③, fig. 14-15). On garrison cap as shown in ④, figure 14-15.

c. When worn. By military personnel while students at officer candidate schools.

14-8. Insignia for warrant officer candidates.

a. Description. Block letters "W.O.C." of gold plated metal, $\frac{7}{16}$ -inch in height, each letter followed by a period (fig. 14-16).

b. How worn. Same as for officer candidates, paragraph 14-7.

c. When worn. By military personnel while students at warrant officer candidate schools.

14-9. Insignia of grade for enlisted personnel.

a. Noncommissioned officers and privates first class. Embroidered chevrons, arcs, lozenges, and stars of gold color on an Army Green, dark blue, or white cloth background 3 inches in width, forming a $\frac{1}{8}$ -inch edging around the entire insignia and $\frac{3}{16}$ -inch space between each $\frac{5}{16}$ -inch chevron and arc (fig. 14-17).

(1) *Sergeant major (E-9).* Three chevrons above the three arcs with a five-pointed star between the chevrons and arcs (①, fig. 14-17).

(2) *First sergeant (E-8).* Three chevrons above three arcs with a lozenge between the chevrons and arcs (②, fig. 14-17).

(3) *Master sergeant (E-8).* Three chevrons above three arcs (③, fig. 14-17).

(4) *Platoon sergeant or sergeant first class (E-7).* Three chevrons above two arcs (④, fig. 14-17).

(5) *Staff sergeant (E-6).* Three chevrons above one arc (⑤, fig. 14-17).

(6) *Sergeant (E-5).* Three chevrons (⑥, fig. 14-17).

(7) *Corporal (E-4).* Two chevrons (⑦, fig. 14-17).

(8) *Private first class (E-3).* One chevron (⑧, fig. 14-17).

Note. Noncommissioned officers in grades E-5, E-6, and E-7, on 31 May 1958, are authorized to continue to wear the insignia and utilize titles appropriate to those grades on that date unless involved in personnel actions which result in promotion or reduction.

b. Army specialists. Embroidered arcs and chevrons $\frac{5}{16}$ -inch in height and an eagle device of gold color on an Army Green or dark blue cloth background 3 inches in width, arched at the top and shaped like an inverted chevron at the bottom, a $\frac{3}{16}$ -inch space between each arc and chevron (fig. 14-18).

(1) *Specialist Seven (E-7).* Three arcs above the eagle device (fig. 14-18).

(2) *Specialist Six (E-6).* Two arcs above the eagle device (fig. 14-18).

(3) *Specialist Five (E-5).* One arc above the eagle device (fig. 14-18).

(4) *Specialist Four (E-4).* Eagle device only (fig. 14-18).

c. How worn. On the outer half of both sleeves on coats, jackets, overcoat Army shade 107 and shirts when worn as the outer garment and on work clothing as shown in figure 14-19. Insignia with Army Green background will be worn with the Army Green, Army Tan, Army Khaki, and work uniforms. Insignia with blue or white background will be worn with the Army Blue or Army White uniform respectively. Chevrons will not be worn on the overcoat Army Green shade 44, the overcoat Army shade 79, the raincoat AG 274 or the raincoat taupe 179.

14-10. Insignia of grade worn by retired personnel. Retired officers and enlisted personnel upon occasions of ceremony will wear the insignia of the grade in which retired. Personnel of the Regular Army who rendered honorable service in time of war in a higher grade than that in which retired may wear at their option when not on active duty and on occasions of ceremony either the insignia of the higher grade or that of the grade in which retired. Officers and enlisted personnel being retired in a higher grade than that in which serving on active duty at time of retirement are authorized, if they desire, to wear the insignia of the higher grade in which being retired while participating in retirement ceremonies.

14-11. Authority for wearing insignia of branch. *a.* (1) *Chief of Staff, former chiefs of staff, and Generals of the Army.* Insignia will be such as they may prescribe.

(2) *All other general officers.* All other general officers are authorized to wear (on an optional basis) the insignia of branch, when appointed in or assigned to duty with an administrative or technical branch.

b. All other officers of the Regular Army and officers on extended active duty will wear the insignia of the branch in which they are assigned or detailed.

c. Officers appointed in the Army of the United States will wear the insignia of branch to which assigned or detailed.

d. Reserve officers and officers of the National Guard in Federal service will wear the same insignia as prescribed for officers of the Regular Army.

e. Retired officers and enlisted men, not on active duty, will wear the insignia of branch in which last assigned.

f. Warrant officers will wear insignia described in paragraph 14-13*a* regardless of assignment.

g. Persons who served honorably in time of war, when wearing the uniform on occasions of ceremony, may wear the insignia of the branch in which last assigned.

h. Enlisted personnel will wear the insignia of the branch of the unit to which they are assigned, except as follows:

(1) When assigned to headquarters or headquarters companies of divisions or higher units or to TD units, individuals will wear the insignia of the branch which indicates their specific assignment. For example, individuals assigned to the Adjutant General section of a division will wear Adjutant General's Corps insignia; those assigned to a finance detachment of a quartermaster class II installation will wear Finance Corps insignia.

(2) When the unit or duty assignment of the individual does not have appropriate branch insignia, he will wear the Unassigned to Branch insignia. For example, enlisted men assigned for duty with a General Staff section; enlisted men assigned for duty with a General Staff section; enlisted men assigned to psychological warfare units.

(3) Basic trainees will not wear insignia of branch.

(4) Upon reassignment, individuals will continue to wear the insignia of their former branch until reporting for new assignment.

(5) Personnel assigned to medical units or sections which are organic to TOE units of other branches will wear the Army Medical Service insignia.

i. The General Staff insignia will be worn by those commissioned officers, other than general officers—

(1) Assigned to the office of the Secretary of the Army, the Under Secretary of the Army, and the Assistant Secretaries of the Army who are authorized by the Secretary of the Army to wear this insignia during their tour of duty in these offices.

- (2) Detailed to duty on the Army General Staff.
- (3) Detailed in General Staff with troops. See AR 614-100.
- (4) As directed by the Chief of Staff.

j. The Inspector General insignia will be worn by The Inspector General and those officers detailed as inspectors general under AR 614-100.

k. National Guard Bureau insignia will be worn by those officers assigned or detailed to the National Guard Bureau and U.S. property and disbursing officers assigned to State National Guard staffs.

l. Staff Specialist, USAR insignia will be worn by Reserve officers not on extended active duty assigned to the Staff Specialist Reserve. See AR 140-10.

m. The Civil Affairs, USAR, insignia will be worn by Reserve officers and enlisted personnel assigned to the Civil Affairs, USAR, while on inactive duty training and while on active duty for training. While on extended active duty those officers will wear the insignia of branch in which they are detailed.

14-12. Insignia of branch—how worn. As used in this section the word "collar" refers to that part of the coat or shirt around the neck which forms a neckband and turnover piece. The word "lapel" will be used when referring to the "revere" of coats.

a. *Officers and warrant officers.*

- (1) On both lapels of the coat as shown in (fig. 14-6).
- (2) On left collar of shirt.

b. *Enlisted personnel.*

- (1) On the left collar of the coat as shown in (fig. 14-6).
- (2) On left collar of shirt as shown in (fig. 14-7). Male enlisted personnel undergoing basic training will not wear insignia of branch.

14-13. Description of insignia of branch. The numerical regimental or battalion designation in $\frac{1}{4}$ -inch numerals for officers and $\frac{3}{16}$ -inch numerals for enlisted personnel on branch insignia for color bearing organizations of battalion size or larger of Armor, Artillery, Corps of Engineers, Infantry, Military Police Corps, Army Medical Service,

Chemical Corps, Intelligence and Security Branch, Ordnance Corps, Quartermaster Corps, Signal Corps, and Transportation Corps is authorized on an optional basis. Multiple piece insignia for enlisted personnel are authorized on an optional basis. Optional items will not be furnished from appropriated funds.

a. *Adjutant General's Corps.*

- (1) *Officers* (①, fig. 14-20). A sterling silver shield 1-inch in height, a chief of blue with 1 large and 12 small silver stars thereon, and 13 vertical stripes, 7 silver and six red.
- (2) *Enlisted personnel* (②, fig. 14-20). A shield consisting of a chief with 1 large and 12 small stars thereon and 13 vertical stripes on a 1-inch disk, all of gold color metal.

b. *Armor.*

- (1) *Officers* (①, fig. 14-21). The front view of a M-26 tank, gun slightly raised, superimposed on two crossed cavalry sabers in scabbards, cutting edge up, $\frac{13}{16}$ -inch in height overall, of gold plated metal.
- (2) *Enlisted men* (②, fig. 14-21). The front view of a M-26 tank, gun slightly raised, superimposed on two crossed cavalry sabers in scabbards, cutting edge up, on a 1-inch disk, all of gold color metal.

c. *Army Medical Service.*

(1) *Officers.*

- (a) *Dental Corps* (①, fig. 14-22). A gold plated metal caduceus, 1-inch in height, with the letter "D" $\frac{3}{8}$ -inch in height in black enamel superimposed thereon.
- (b) *Medical Corps* (②, fig. 14-22). A gold plated metal caduceus, 1-inch in height.
- (c) *Medical Service Corps* (③, fig. 14-22). A sterling silver caduceus, 1-inch in height, with a monogram consisting of the letters "MS" $\frac{3}{8}$ -inch in height in black enamel superimposed thereon.
- (d) *Veterinary Corps* (④, fig. 14-22). A gold plated metal caduceus, 1-inch in height, with the letter "V" $\frac{3}{8}$ -inch in height in black enamel superimposed thereon.
- (e) *Army Nurse Corps* (⑤, fig. 14-22).

A gold plated metal caduceus 1-inch in height with the letter "N" $\frac{3}{8}$ -inch in height in black enamel superimposed thereon.

- (f) *Army Medical Specialist Corps* (⑥, fig. 14-22). A gold plated metal caduceus, 1-inch in height, with a monogram consisting of the letter "S" $\frac{3}{8}$ -inch in height in black enamel superimposed thereon.

- (2) *Enlisted personnel* (⑦, fig. 14-22). A caduceus on a 1-inch disk, all of gold color metal.

d. *Unassigned to branch—enlisted personnel* (fig. 14-24). The coat of arms of the United States on a 1-inch disk, all of gold color metal.

e. *Artillery.*

- (1) *Officers* (①, fig. 14-23). A missile surmounting two crossed field guns, all of gold plated metal $1\frac{1}{8}$ inches in height.
- (2) *Enlisted personnel* (②, fig. 14-23). A missile surmounting two crossed field guns on a 1-inch disk, all of gold color metal.

f. *Chaplains.*

- (1) *Christian faith* (①, fig. 14-25). A sterling silver Latin cross 1-inch in height.
- (2) *Jewish faith* (②, fig. 14-25). A double tablet bearing Roman numerals from I to X surmounted by two equilateral triangles interlaced, all of sterling silver 1-inch in height.

g. *Chemical Corps.*

- (1) *Officers* (①, fig. 14-26). A benzene ring of cobalt blue enamel superimposed in the center of crossed gold color retorts, $\frac{1}{2}$ -inch in height and $1\frac{3}{16}$ inches in width overall.
- (2) *Enlisted personnel* (②, fig. 14-26). A benzene ring superimposed in the center of crossed retorts on a 1-inch disk, all of gold plated metal.

h. *Civil Affairs, USAR.*

- (1) *Officers* (①, fig. 14-27). On an armillary globe $\frac{5}{8}$ -inch in diameter, a torch of Liberty 1-inch in height surmounted by a scroll and sword crossed in saltire, all of gold color.
- (2) *Enlisted personnel* (②, fig. 14-27). On an armillary globe, a torch of Liberty

surmounted by a scroll and sword crossed in saltire, on a 1-inch disk, all of gold color metal.

i. *Corps of Engineers.*

- (1) *Officers* (①, fig. 14-28). A gold plated metal triple-turreted castle $1\frac{1}{16}$ -inch in height.
- (2) *Enlisted personnel* (②, fig. 14-28). A triple-turreted castle on a 1-inch disk, all of gold color metal.

j. *Finance Corps.*

- (1) *Officers* (①, fig. 14-29). A gold plated metal diamond, 1 inch by $\frac{3}{4}$ -inch, short axis vertical.
- (2) *Enlisted personnel* (②, fig. 14-29). A diamond on a 1-inch disk, all of gold color metal.

k. *General Staff—officers* (fig. 14-30). The coat of arms of the United States, $\frac{5}{8}$ -inch in height, of gold plated metal superimposed on a five-pointed sterling silver star, 1-inch in circumscribing diameter. The shield and glory to be in enamel stripes of white and red, chief of blue, and the sky of the glory blue.

l. *Infantry.*

- (1) *Officers* (①, fig. 14-31). Two gold plated metal crossed muskets $\frac{3}{4}$ -inch in height.
- (2) *Enlisted personnel* (②, fig. 14-31). Two crossed muskets on a 1-inch disk all of gold color metal.

m. *Inspector General—officers* (fig. 14-32). A sword and fasces $\frac{3}{4}$ -inch in height, crossed and wreathed in gold plated metal with the inscription "Droit et Avant" (Right and Forward) in blue enamel on upper part of wreath.

n. *Military Intelligence Branch.*

- (1) *Officers* (①, fig. 14-33). On a gold plated metal dagger, point up. $1\frac{1}{4}$ inches overall in height, a gold plated metal heraldic sun composed of 4 straight and 4 wavy alternating rays surmounted by a gold heraldic rose, the petals dark blue enamel.
- (2) *Enlisted personnel* (②, fig. 14-33). A dagger, point up, $\frac{7}{8}$ -inch over all in height, surmounted by a heraldic sun composed of 4 straight and 4 wavy alternating rays and charged with a heraldic rose, on a 1-inch disk, all gold color metal.

o. *Judge Advocate General's Corps.*

- (1) *Officers* (①, fig. 14-34). A gold plated

metal sword and pen crossed and wreathed, $1\frac{1}{16}$ -inch in height.

- (2) *Enlisted personnel* (②, fig. 14-34). A sword and pen crossed and wreathed, $\frac{7}{16}$ -inch in height on a 1-inch disk, all of gold color metal.

p. Military Police Corps.

- (1) *Officers* (①, fig. 14-35). Two crossed gold plated metal pistols $\frac{3}{4}$ -inch in height.
- (2) *Enlisted personnel* (②, fig. 14-35). Two crossed pistols on a 1-inch disk, all of gold color metal.

q. National Guard Bureau—officers (fig. 14-36).

Two crossed gold plated metal fasces superimposed on an eagle displayed with wings reversed, $\frac{3}{4}$ -inch in height.

r. Ordnance Corps.

- (1) *Officers* (①, fig. 14-37). A gold plated metal shell and flame 1-inch in height.
- (2) *Enlisted personnel*. (②, fig. 14-37). A shell and flame on a 1-inch disk, all of gold color metal.

s. Quartermaster Corps.

- (1) *Officers* (①, fig. 14-38). A gold plated metal sword and key crossed on a wheel surmounted by a flying eagle, the felloe of the wheel set with 13 stars. The felloe of the wheel to be of blue enamel hub center red edged with white. Insignia $\frac{3}{4}$ -inch in height.
- (2) *Enlisted personnel* (②, fig. 14-38). A sword and key crossed on a wheel surmounted by a flying eagle, the felloe of the wheel set with 13 stars on a 1-inch disk, all of gold color metal.

t. Signal Corps.

- (1) *Officers* (①, fig. 14-39). Two signal flags crossed, dexter flag white with red center, the other flag red with white center, staffs gold, with a flaming torch of gold plated metal upright at center of crossed flags; $\frac{7}{8}$ -inch in height.
- (2) *Enlisted personnel* (②, fig. 14-39). Two signal flags crossed with a flaming torch upright at center of crossed flags on a 1-inch disk, all of gold color metal.

u. Staff Specialist, USAR—officers (fig. 14-40).

A sword $1\frac{3}{8}$ -inches in length laid horizontally across the upper part of an open book. Below the sword and across the lower corners of the book two

laurel branches crossed at stems. Insignia $1\frac{3}{16}$ -inch in height, of gold plated metal.

v. Transportation Corps.

- (1) *Officers* (①, fig. 14-41). A ship's steering wheel, superimposed thereon a shield charged with a winged car wheel on a rail, all of gold plated metal 1-inch in height.
- (2) *Enlisted personnel* (②, fig. 14-41). A ship's steering wheel, superimposed thereon a shield charged with a winged car wheel on a rail, on a 1-inch disk, all of gold color metal.

w. The Sergeant Major of the United States Army. (fig. 14-42). A shield $\frac{3}{4}$ -inch in height of gold color metal base divided diagonally from lower left right, the upper part red, the lower part white, on which is a silver five-pointed star surmounted by the coat of arms of the United States in color, between 2 white five-pointed stars at top and 2 red five-pointed stars in base, the shield on a 1-inch disk of gold color metal.

x. Warrant Officers (fig. 14-43). An eagle rising with wings displayed standing on a bundle of two arrows, all inclosed in a wreath, all gold plated metal $\frac{3}{4}$ -inch in height. (Worn by all warrant officers in lieu of branch insignia.)

14-14. Insignia of aides. *a. Description.*

- (1) *Aides to President of United States* (fig. 14-44). On a blue shield $\frac{3}{4}$ -inch in height, surmounted by a gold plated metal eagle displayed with wings reversed $\frac{1}{2}$ -inch in height, a circle of 13 white stars.
- (2) *Aides to Secretary of Defense* (fig. 14-45). On a blue shield $\frac{3}{4}$ -inch in height surmounted by a gold plated metal eagle displayed with wings reversed $\frac{1}{2}$ -inch in height, three crossed arrows in gold plated metal between four white enameled stars (two and two).
- (3) *Aides to Secretary of Army* (fig. 14-46). On a red shield $\frac{3}{4}$ -inch in height, surmounted by a gold plated metal eagle displayed with wings reversed $\frac{1}{2}$ -inch in height, the coat of arms of the United States in gold plated metal between four white enameled stars (two and two).
- (4) *Aides to Under Secretary of Army* (fig. 14-46). On a white shield $\frac{3}{4}$ -inch in height, surmounted by a gold plated

metal eagle displayed with wings reversed $\frac{1}{2}$ -inch in height, the coat of arms of the United States in gold plated metal between four red enameled stars (two and two).

- (5) *Aides to Chief of Staff* (fig. 14-47). On a shield $\frac{3}{4}$ -inch in height divided diagonally from lower left to upper right, the upper part red and the lower part white, a silver five-pointed star surmounted by the coat of arms of the United States in color, between 2 white five-pointed stars at top and 2 red five-pointed stars in base, with a gold plated metal eagle with wings reversed $\frac{1}{2}$ -inch in height placed above the shield.
- (6) *Aides to General of Army* (fig. 14-48). On a blue shield $\frac{3}{4}$ -inch in height, surmounted by a gold plated metal eagle displayed with wings reversed $\frac{1}{2}$ -inch in height, five white stars arranged in a circle, inner points touching.
- (7) *Aides to other general officers*. A shield $\frac{3}{4}$ -inch in height surmounted by a gold plated metal eagle displayed with wings reversed $\frac{1}{2}$ -inch in height, on a blue chief of shield a white star or stars, according to the grade of the general officer on whose staff the aide is serving; and 13 vertical stripes, 7 white and 6 red.
 - (a) *General*. Four stars (fig. 14-49).
 - (b) *Lieutenant general*. Three stars (fig. 14-50).
 - (c) *Major general*. Two stars (fig. 14-51).
 - (d) *Brigadier general*. One star (fig. 14-52).

b. How worn. See paragraph 14-12.

14-15. Permanent professors, registrar, and civilian instructors, U.S. Military Academy. *a. Description.* Coat of arms of the U.S. Military Academy 1-inch in height, the shield of the United States bearing the helmet of Pallas over a Greek sword and surmounted by an eagle displayed with scroll and motto, all of gold plated metal (fig. 14-53.)

b. How worn. See paragraph 14-12.

14-16. Organization shoulder sleeve insignia.

a. Authorization.

- (1) Approved designs of shoulder sleeve insignia are prescribed for wear by person-

nel of units assigned to one of the organizations listed below.

- (a) Office, Commanding General, U.S. Continental Army Command and other Continental Army Command organizations not assigned to one of the organizations listed below: Same design for all units.
- (b) Office, Commanding General, U.S. Army Materiel Command and subordinate Army Materiel Commands, units, activities, and installations: Same design for all elements.
- (c) Office, Commanding General, U.S. Combat Developments Command and subordinate elements: Same design for all elements.
- (d) Class II installations, organizations, units, and detachments under the command of the Chief of Staff, DA General and Special Staff: Same design for personnel of all organizations, units and detachments so assigned.
- (e) Major oversea commands: One for each command.
- (f) Armies: One for each army.
- (g) Corps: One for each Corps.
- (h) Divisions: One for each division.
- (i) Separate brigades (not organic to a division): One for each brigade.
- (j) Separate regiments (not assigned to a group, brigade or division and having at least three battalion level units under direct command).
- (k) Military District of Washington, U.S. Army.
- (l) Base commands: One for each command.
- (m) Logistical commands: One for each command.
- (n) Defense commands: One for each command.
- (o) For Airborne organizations authorized a separate shoulder sleeve insignia an "AIRBORNE" tab, with letters $\frac{5}{16}$ -inch in height will be worn immediately above and touching the organization insignia to complete the design.
- (p) Army personnel assigned or attached for duty with or advisors to foreign

- governments, except Army attachés: Same design for all personnel.
- (q) Units which have been granted specific authority for shoulder sleeve insignia by Headquarters, Department of the Army.
 - (r) Engineer Amphibious Support Commands: Same design for all commands, with tab on which is placed the applicable numerical designation of each command in capital letters.
 - (s) Missile Commands: Same design for all commands, with tab on which is placed the applicable numerical designation of each command in Arabic numeral(s).
 - (t) Army personnel assigned for duty in Vietnam: Same design for all personnel.
 - (u) Strategic Communications Command.
- (2) Members of units which are not authorized organizational shoulder sleeve insignia listed in (1) above, and personnel assigned to schools and boards will wear the insignia of the corps, Army, or over-sea command to which they are assigned.
 - (3) Individuals being transferred from one organization to another may continue to wear the insignia of the former unit until reporting for duty at the new organization.
 - (4) Members of the Army Reserve assigned to a TOE or TD organization authorized organizational insignia will wear that insignia. Members of USAR TOE or TD units not authorized organizational insignia will wear the insignia of the U.S. Army Corps in which the unit is located. In those cases where subordinate elements of a USAR TOE or TD unit are located in more than one U.S. Army Corps, the subordinate element will wear the same organizational insignia as the parent headquarters. Members attached to USAR reinforcement training units authorized organizational insignia may wear that insignia. Members attached to a USAR reinforcement training unit not authorized organizational insignia may wear the insignia of the U.S. Army Corps in which the unit is located. Mobilization designees will wear the insignia of the organization to which designated. Individuals not assigned to TOE or TD units or attached to reinforcement training units, except mobilization designees, will wear no insignia.
- (5) Members of the National Guard not in active Federal service will wear the organizational shoulder sleeve insignia of the organization to which assigned.
 - (a) National Guard members assigned to State headquarters and headquarters detachments may wear appropriate State insignia.
 - (b) Members of Army National Guard air defense missile battalions that have been placed under Commanding General, U.S. Army Air Defense Command, for supervision of training, and assigned an onsite CONUS air defense mission, may wear the organization shoulder sleeve insignia of the U.S. Army Air Defense Command. This authorization is effective on or subsequent to the date a unit of that organization is authorized to assume its onsite operational mission.
 - (c) Members of other nondivisional Army National Guard units not authorized organizational insignia may, as determined by the adjutant general for each State or territory, wear either of the following insignia:
 1. Insignia of the State headquarters and headquarters detachments.
 2. Insignia of the Army in which area the unit is located. Except as authorized in (b) above, the insignia selected will be worn by all non-divisional Army National Guard units of the State.
 3. Insignia of the Command Headquarters, Divisional, to which they are attached.
 - (6) Trainees will not wear organizational shoulder sleeve insignia prior to completion of basic training, Active Army trainees reporting to their assigned TOE or TD organization for completion of indi-

vidual training (OJT) are authorized to wear the insignia of organization to which assigned. Upon completion of basic training, REP trainees reporting to a TOE or TD organization for advanced individual training OJT and completion of active duty training are authorized to wear the insignia of the Reserve component organization to which assigned. Active Army and REP trainees, taking advanced individual training at U.S. Army training centers and service schools will not wear the insignia until completion of that training.

b. How worn. On the upper part of the left sleeve of the service coat; overcoat, cotton, olive green, Army shade 107; field jacket; and the shirt when worn as an outer garment, as shown in figure 14-54. When tabs are worn, the uppermost tab will be placed 1/2-inch below top of shoulder seam. The organizational insignia will be lowered accordingly. Shoulder sleeve insignia will not be worn on the overcoat, wool, taupe, Army shade 79; the overcoat, wool, gabardine, Army Green shade 44; any dress uniforms; nor on the short sleeve shirt, except as provided below.

c. Personnel assigned to Headquarters, Department of the Army. There is no shoulder sleeve insignia approved for wear by personnel assigned to Headquarters, Department of the Army. Accordingly, except as provided above, personnel assigned to Headquarters, Department of the Army will wear no shoulder sleeve insignia on the left sleeve.

14-17. Ranger tab. *a. Individually awarded as outlined in AR 672-5-1.* Of adopted design 1 1/16-inch in height, 2 3/8 inches in width, consisting of black background with 1/8-inch yellow border inscribed RANGER in yellow letters 5/16-inch high.

b. How worn. The tab is worn 1/2-inch below the shoulder seam on the left shoulder. It may be worn on the following items of clothing:

Shirt, cotton sateen, olive green, shade 107.

Shirt, wool serge, Army Green, shade 44.

Shirt, cotton khaki uniform twill, short sleeve.

Coat, cotton wind resistant sateen, olive green, shade 107.

Coat, wool serge, Army Green, shade 44.

Coat, lightweight, Army Green, shade 344.

Coat, Army tan.

c. How worn. Organization shoulder sleeve in-

signia, when authorized, will be worn 1/4-inch below Ranger tab.

14-18. Combat leader's identification. *a.* The combat leader's identification will be worn by commanders of Regular Army, Army Reserve, and Army National Guard units whose mission it is to combat the enemy by direct means or methods, or units at corps level or below whose mission is to control or directly support such units.

b. Commanders of the units listed and as may be designated in accordance with *f* and *g* below, are authorized to wear this identification. Specifically, these commanders are—

- (1) Corps commanders.
- (2) Division commanders and assistant division commanders.
- (3) Brigade commanders.
- (4) Division and Corps artillery commanders.
- (5) Combat command and division trains commanders.
- (6) Regimental, group, and battle group commanders.
- (7) Battalion and squadron commanders.
- (8) Company, troop and battery commanders.
- (9) Platoon leaders.
- (10) Detachment and team commanders.
- (11) Sergeants major.
- (12) First sergeants.
- (13) Platoon sergeants.
- (14) Section leaders (when so designated in TOE).
- (15) Squad leaders and tank commanders.
- (16) Missile command commanders.

c. The units referred to in *a* above, are—

- (1) Infantry, Armor, and Airborne divisions and the component units thereof.
- (2) Engineer special brigades, amphibious support brigades, component units thereof; and separate similar units.
- (3) All Infantry, Armor, and Artillery units.
- (4) Engineer combat battalions, combat groups, and the component units thereof.
- (5) Mortar battalions.
- (6) Chemical smoke generator battalions and companies.
- (7) Headquarters and headquarters companies, corps, and Military Police units assigned or attached to corps headquarters.

- (8) Signal battalion, corps.
- (9) Army Missile Commands and the component units thereof.
- (10) Field Artillery Missile Groups and the component units thereof.
- (11) Chemical Company, Combat Support.
- (12) Transportation Tactical Carrier Units.

d. This identification will be a green cloth loop, $1\frac{5}{8}$ inches wide, worn in the middle of both shoulder loops of the service coat, jacket, overcoat, or shirt when worn as an outer garment (fig. 14-55).

e. Combat leader's identification will cease to be worn when an individual entitled thereto is reassigned from a command position or from a combat unit as defined in *b* and *c* above.

f. Action may be initiated by major commanders to secure the designation of additional type units other than those defined in *c* above. Such recommendations will be forwarded through channels to The Institute of Heraldry, Cameron Station, Alexandria, Va.

g. Oversea commanders are authorized to designate units not included in *c* above, as units whose otherwise eligible personnel are entitled to wear the combat leader's identification.

h. The Commanding General, U.S. Army Security Agency is authorized to designate those U.S. Army Security Agency units and command personnel entitled to wear the combat leaders identification when those units and command personnel are in direct tactical support of combat units at corps level or below.

14-19. Distinctive insignia; background trimming; airborne insignia; and flash. *a. Distinctive insignia.* Subject to approval of The Institute of Heraldry, U.S. Army in each case, a distinctive insignia for wear on the uniform as a means of promoting esprit de corps is authorized for color-bearing organizations (regiments and battalions, fixed-type), flexible battalions, U.S. Army service schools established by the Department of the Army, and noncolor-bearing units of divisions and separate brigades (one design for the division/separate brigade). Organizations not in the previously stated category, but which have a distinctive insignia by virtue of a previous Headquarters, Department of the Army authority are permitted to retain that distinctive insignia if it had been

manufactured and worn by members of the subject organization.

(1) When a distinctive insignia is authorized, the insignia will be worn by all assigned personnel of the organization. Unit funds of the organization will be used to provide newly joined enlisted personnel with one complete set of the distinctive insignia without cost to the individual soldier. A complete set of distinctive insignia consists of three pieces of insignia: one for each shoulder loop, and one for headgear (garrison cap; utility cap; beret). Expenditure of nonappropriated unit funds for the procurement of distinctive insignia not authorized by The Institute of Heraldry, U.S. Army, and manufactured in accordance with AR 672-8 is prohibited. Distinctive insignia will not be purchased through the use of appropriated funds.

(2) Distinctive insignia will be worn as prescribed and shown by figure 14-56 and figure 14-1.

b. Background trimming. Subject to the approval of The Institute of Heraldry, U.S. Army in each case, a background trimming is authorized for organizations designated "airborne" by Headquarters, Department of the Army for wear with the parachutist badges. When a background trimming has been authorized, such background trimming will be worn by all personnel of the organization who have been awarded one of the parachutist badges. Unit funds of the organization will be used to provide newly joined enlisted personnel with the background trimming without cost to the individual soldier. Background trimmings will not be purchased through the use of appropriated funds.

c. Airborne insignia. Airborne insignia may be worn when prescribed by airborne organization commanders. The insignia consists of a white parachute and glider on a blue disk, with a red border, approximately $2\frac{1}{4}$ inches in diameter, overall.

(1) Wear: Officers: On the garrison cap, centered on the right curtain, 1 inch from the front. Enlisted personnel: On the garrison cap, centered on the left curtain, 1 inch from the front.

- (2) Unit funds of the organization will be used to provide newly joined enlisted personnel with one such insignia. Airborne insignia will not be purchased through the use of appropriated funds.

d. Flash. A shield-shaped felt flash with a semi-circular bottom approximately $1\frac{7}{8}$ inches wide, $2\frac{1}{4}$ inches high, centered upon the stiffener of the beret (para 13-2) is authorized for MOS prefix "3" qualified officer personnel and special qualification identifier "S" qualified enlisted personnel assigned to: Special Forces Organizations; U.S. Army John F. Kennedy Center for Special Warfare; and the U.S. Army Special Warfare School. Flashes will be worn by all qualified personnel of the organization. Distinctive insignia, if authorized, will be worn by enlisted personnel centered on the flash. Insignia of grade will be worn by officer personnel centered on the flash. Color selection and/or color combination of the flash will be as approved for each organization by the Institute of Heraldry, U.S. Army. Unit funds of the organization will be used to provide newly joined enlisted personnel with the flash for wear on the beret. The flash will not be purchased through the use of appropriated funds.

14-20. Aiguillette, service. *a. Description.* Braided gold cord, or gold color nylon cord, $\frac{3}{16}$ -inch in diameter, $30\frac{1}{2}$ inches in length in one piece, each end equipped with a hook, one end equipped with an eye. Front part $8\frac{1}{4}$ inches in length, consisting of $1\frac{1}{2}$ inches of cord equipped with a hook, a knot $1\frac{3}{4}$ inches in length, a cord 2 inches in length, and a 3-inch ferrule (①, fig. 14-57).

b. How worn. On the right side by the Military Aide to the President, White House Social Aides while on duty with the First Family, and officers designated as aides to foreign heads of State. All other aides and Army attachés will wear aigullettes on the left side. The cord is placed around and under the arm, with the hooks engaging eyes on each side of the appropriate shoulder loop, the end equipped with the eye to the front. The hook of the front part is engaged in the eye on the cord (②, fig. 14-57). Either gold cord or gold color nylon cord may be worn, depending upon the importance of the occasion and the individual preference.

c. By whom worn. Army attachés, assistant army attachés, and aides will wear the service aiguillette with the service uniform on all occasions. This aiguillette will also be worn with the Army Blue and Army White uniforms on those occasions when a four-in-hand necktie is worn. When the overcoat is worn, service aiguillette may be worn on the outside of the overcoat. Aigullettes will not be worn on the olive green coat, raincoat, or cape.

d. How to obtain. Aigullettes will be procured locally as expendable property by the organization to which the individual is assigned for supply purposes. One each of gold cord and gold color nylon cord is authorized in both service and dress aigullettes.

14-21. Aiguillette, dress. *a. Description.* Front consists of the service aiguillette shown in ①, figure 14-57, omitting front part service aiguillette and substituting a front part (①, fig. 14-58) 25 inches in length, with 15 inches of braiding, 2 inches from braiding to button loop and knot, knot $1\frac{3}{4}$ inches in length, cord $3\frac{1}{4}$ inches and ferrule 3 inches. Braided end is equipped with a hook. Back (②, fig. 14-58) consisting of a braided gold cord, or gold color nylon cord, $\frac{3}{16}$ -inch in diameter, $30\frac{1}{2}$ inches in length, with an additional part 34 inches in length consisting of 24 inches of braiding, 2 inches from braiding to button loop and knot, knot $1\frac{3}{4}$ inches in length, cord $3\frac{1}{4}$ inches, and ferrule 3 inches, fastened to a triangular piece of brass having a hook on the inside, this hook to attach to a small strip of brass which slips under the shoulder loop, shoulder strap, or shoulder knot. The brass strip for shoulder strap is curved to conform to contour of shoulder $\frac{5}{8}$ -inch in width and $3\frac{7}{8}$ inches in length, with a rectangular opening at each end $\frac{3}{8}$ -inch in length. The brass strip for shoulder knots is $\frac{5}{8}$ -inch in width and $3\frac{3}{8}$ inches in length, with an extra piece fastened thereto to form a standing loop 1-inch in length to permit the flexible backing of the shoulder knot to pass through. The brass strip for shoulder loop of white dress coat is the same as that used for shoulder knot, without the standing loop.

b. How worn. On the right side by the Military Aide to the President, White House Social Aides while on duty with the First Family, and officers designated as aides to foreign heads of State. All other authorized personnel will wear aigullettes

on the left side. Secured to the coat before buttoning, with the service aiguillette with both hooks attached to front opening of the brass strip and the front part hooked into eye of service aiguillette; and the 34-inch part attached to the rear opening of the brass strip as shown. Pass the cord of the 34-inch part under the arm and insert the button loop of the 25-inch part through the button loop of the 34-inch part. Pass button loop of the 25-inch part through notch in lapel and attach to the button under the collar. The button under the collar is attached to the body of the coat in such a position that the knot of the 25-inch part will easily clear the notch in the lapel. The loops of both cords to cross on the outside of the arm with front loop on top. Either gold cord or gold color nylon may be worn, depending upon the importance of the occasion and the individual preference.

c. By whom worn (③ and ④, fig. 14-58). Officers regularly detailed on the Army General Staff, Army attachés, Assistant Army attachés, and aides will wear the dress aiguillette with the Army Evening Dress uniform on all occasions, and with the Army Blue, Army White, and mess uniforms when prescribed. This aiguillette will not be worn with the Army Blue or Army White uniform on those occasions when a four-in-hand necktie is worn.

d. How to obtain. See paragraph 14-20*d*.

14-22. Insignia, distinguishing, "U.S. Army."

a. Description. Of adopted specification, 4½ inches in length and 1 inch in width, consisting of "U.S. Army" in black block letters ¾-inch in height on an OG background (fig. 14-59).

b. How worn. On the upper left breast (¼- to ⅜-inch above the top edge of pocket or comparable position on garment with no pocket) of the following items of field clothing:

- (1) Shirt, cotton sateen, olive green, Army shade 107.
- (2) Coat, cotton wind resistant sateen, olive green, Army shade 107.
- (3) Shirt, wool, 16-oz., olive green, Army shade 108.
- (4) Parka, cotton-nylon oxford, olive green, Army shade 107.

14-23. Service stripes. *a. Description.* Gold colors rayon stripe 1½ inches in length, ⅜-inch in width within an Army Green schragg stitch border ⅜-inch around the stripe on a cloth background of Army Green shade 159. As an optional

item the stripe may be of lace or bullion (fig. 14-60).

b. How worn. On the outside half of the left sleeve of the service coat, placed at the angle of 45 degrees, the lower end toward the inside seam of the sleeve as shown in figure 14-19. For each additional period of 3 years, another stripe will be worn above and parallel to the first stripe, with ¼-inch background space between stripes.

c. By whom worn. Worn by enlisted personnel of the Army, Army National Guard, and Army Reserve who have served honorably in active Federal service as commissioned officers, warrant officers, or enlisted men in the Army, Navy, Air Force, or Marine Corps. One stripe is authorized for each 3 years of active Federal service which may have been earned on a continuous basis or otherwise.

14-24. Organization shoulder sleeve insignia of former wartime unit.

a. How worn. Former organization shoulder sleeve insignia approved by Headquarters, Department of the Army may be worn (not required) by individuals on the right shoulder of the service coat, field jacket and shirt when worn as an outer garment in the same relative position as indicated in paragraph 14-16*b* (fig. 14-54).

b. By whom worn. This authority is extended only to individuals who served overseas with U.S. Army organizations during the following periods:

- (1) World War II between 7 December 1941 and 2 September 1946, both dates inclusive.
- (2) In Korea between 27 June 1950 and 27 July 1954, both dates inclusive.
- (3) In Vietnam subsequent to 1 July 1958.
- (4) In the Dominican Republic subsequent to 29 April 1965. Individuals returning from the Dominican Republic subsequent to 29 April 1965, will be authorized to wear, on the right shoulder, one of four organizational shoulder sleeve insignia: OEA, XVIII Airborne Corps, 82d Airborne Division, or 5th Logistical Command. Individuals previously attached, assigned, or under operational control of the XVIII Airborne Corps, 82d Airborne Division, or 5th Logistical Command will wear their respective insignia. Only those individuals who do not fall into the cate-

gory of the original three units will wear the "OEA Patch" on the right shoulder.

14-25. Oversea service bars (World War II, Korean Service, Vietnam Service, and the Dominican Republic). *a. Description.* Gold color rayon bar $1\frac{5}{16}$ -inches in length, $\frac{3}{16}$ -inch in width within an Army Green schragg stitch border $\frac{3}{32}$ -inch around the bar, on a cloth background of Army Green shade 159. As an optional item the bar may be of lace or bullion (fig. 14-61).

b. How worn. Worn centered on the outside half of the right sleeve with the lower edge of the bar $\frac{1}{4}$ -inch above braid of Army Green coat and 4 inches above the parallel to the end of the sleeve of the other service coats. Additional bars will be worn parallel to and above the first bar with $\frac{1}{16}$ -inch space between bars, the space being formed of the background. Oversea service bars will be worn as shown in figure 14-19.

c. By whom worn.

- (1) One overseas service bar is authorized for wear for each period of 6 months' active Federal service as a member of the U.S. Army outside the continental limits of the United States from 7 December 1941 until 2 September 1946, both dates inclusive. In computing overseas service, the former Territory of Alaska will be considered outside the continental limits of the United States. An overseas service bar is not authorized for a fraction of a 6-month period.
- (2) One overseas service bar is authorized for each period of 6 months' active Federal service as a member of the U.S. Army in Korea from 27 June 1950 until 27 July 1954, both dates inclusive.
- (3) One overseas service bar is authorized for each period of 6 months' active Federal service as a member of the U.S. Army in Vietnam subsequent to 1 July 1958.
- (4) One overseas service bar is authorized for each 6 months' active Federal service as a member of the U.S. Army in the Dominican Republic subsequent to 29 April 1965.
- (5) Service in World War II, Korea, Vietnam, and the Dominican Republic, of periods less than 6 months' duration, which otherwise meets the requirements

for the award of overseas bars may be combined to determine the total number of overseas bars authorized.

d. Computation of World War II service.

- (1) Service is computed between dates of departure from and arrival at a port in the United States or the boundary of the continental United States. The day of departure and day of return are included. The expression "each period of 6 months' service" is interpreted to authorize wearing an overseas service bar for overseas service of various lengths performed either continuously or at intervals, when the total of the service equals or exceeds 6 months. Thus, an individual who serves 4 months and 10 days outside the continental United States and returns thereto and subsequently departs from the United States to the same or another theater or country and serves an additional 1 month and 20 days is entitled to one bar. All active duty or service outside the continental United States (permanent, temporary, detached, etc.) will be included in computing length of service, provided that the official duty of the individual required his presence outside the continental United States.
- (2) Military personnel serving on transport vessels and on aircraft become eligible to wear the bar when their total service outside the continental United States equals or exceeds 6 months.
- (3) Service on the Great Lakes and in any harbor, bay, or other inclosed arm of the sea along the coast and that part of the sea which is within 3 miles of the continental limits of the United States will not be included in computing length of service required.
- (4) Periods during which military personnel are absent without leave or in desertion will not be included in computing length of service required.
- (5) Periods during which military personnel are in the United States on temporary duty, detached service, and/or leave (even though the individual is assigned

to overseas) will not be included in computing length of service required.

- (6) Periods during which military personnel are in confinement which result in time lost as described in the Uniform Code of Military Justice, section 6, will not be included in computing length of service required.

14-26. Brassards. *a. Purpose.* Brassards are used in the military service as a mark of identification that may be used as a temporary or occasional expedient for designating personnel who may be required to perform a special task or to deal with the public.

b. General description. Brassard will be of cloth, 18 inches in length and 4 inches in width (unless otherwise described), of the color specified. When the brassard consists of more than one color, the colors will be of equal width and will run lengthwise on the brassard.

c. Wear. On left sleeve of outer garment as shown in figure 14-62.

14-27. Acting officers' brassard. *a. Description.* On an olive-drab background, stripes of the colors and number indicated below, centered and parallel with the long side.

- (1) *Captain.* Three white stripes (①, fig. 14-63).
- (2) *First lieutenant.* Two white stripes (②, fig. 14-63).
- (3) *Second lieutenant.* One white stripe (③, fig. 14-63).

b. By whom worn. Worn by trainees or candidates acting as officers in schools and training centers.

14-28. Acting noncommissioned officers' brassard. *a. Description.* On a dark blue background, gold color chevrons centered on the brassard.

- (1) *Sergeant.* Three chevrons (①, fig. 14-64).
- (2) *Corporal.* Two chevrons (②, fig. 14-64).

b. By whom worn. Worn by trainees or candidates acting as noncommissioned officers in schools and training centers.

14-29. Armed Forces Police brassard. *a. Description.* On a black cloth background the words "Armed Forces Police" (on three lines) in yellow block letters (fig. 14-65).

b. By whom worn. Worn by members of Armed Forces Police detachments while on duty.

14-30. Explosive Ordnance Disposal brassard. *a. Description.* On a dark blue background, a black projectile shape, point downward, a red conventionalized drop bomb fimbriated in yellow (fig. 14-66).

b. By whom worn. Worn by Explosive Ordnance Disposal personnel while performing disposal activities.

14-31. Gas brassard. *a. Description.* On a cobalt blue background the word "Gas" in golden orange letters (fig. 14-67).

b. By whom worn. Worn by personnel assigned gas duties in a theater of operations.

14-32. Geneva Convention brassard. *a. Description.* On a white background, a red Geneva cross (fig. 14-68).

b. By whom worn. Worn by all persons in the military service rendered neutral by the terms of the Geneva Convention in time of war.

14-33. Military Police brassard. *a. Description.* On a dark blue background 20 inches long and $4\frac{1}{8}$ inches wide, with an extension $5\frac{11}{16}$ inches high centered above for display of shoulder sleeve insignia, the block letters "MP" in white, $2\frac{1}{2}$ inches in height (fig. 14-69).

b. By whom worn. Worn by members of the Military Police Corps and other designated personnel of units detailed to military police missions when prescribed by the commanding general.

14-34. Mourning brassard. *a. Description.* Plain black or black crepe.

b. By whom worn. On military uniform. At discretion of wearer, only when actually present at a funeral or en route thereto or therefrom, or by funeral escorts when and as prescribed by the Secretary of the Army.

14-35. Movement control brassard. *a. Description.* On a brick-red background, the words "Movement Control" in golden yellow block letters (fig. 14-70).

b. By whom worn. Worn by movement control military personnel and other designated personnel, when prescribed, in the field.

14-36. Officer of day brassard. *a. Description.* On a dark blue background, yellow letters "OD" in block type (fig. 14-72).

b. By whom worn. Worn by the officer of the day as designated by commanders of installations.

14-37. Officer of guard brassard. *a. Description.* On a dark blue background, yellow letters "OG" in block type (fig. 14-71).

b. By whom worn. Worn by the officer of the guard as designated by commanders of installations.

14-38. Photographer brassard. *a. Description.* On an ultramarine blue background, the word "U.S. Army Photographer" in golden orange letters (fig. 14-73).

b. By whom worn. Worn by designated U.S. Army photographers when actually performing photographic duty.

14-39. Port brassard. *a. Description.* On a brick-red background, the letters "TC" in golden yellow block letters (fig. 14-74).

b. By whom worn. Worn by military personnel of the Transportation Corps when prescribed by the port or Army terminal commander.

14-40. Trainees in leadership courses brassard. *a. Description.* On a dark blue background, a golden yellow and dark blue "compass rose" (fig. 14-75).

b. By whom worn. Worn by all students attending leadership courses.

14-41. Unit police brassard. *a. Description.* On a dark blue background, the letters "UP" in yellow block letters (fig. 14-76).

b. By whom worn. Worn by Army personnel, other than members of the Military Police Corps while performing as unit traffic guides, courtesy patrols, security guards, and other police type functions when prescribed by the commanding officer.

14-42. Veterinary Corps brassard. *a. Description.* On a white background, a green cross (fig. 14-77).

b. By whom worn. Worn by members of veterinary service when prescribed.

14-43. Colors of branches. *a. Adjutant General's Corps.* Dark blue piped with scarlet (cable Nos. 65012 and 65006).

b. Armor. Yellow (cable No. 65002).

c. Artillery. Scarlet (cable No. 65006).

d. Chaplains. Black (cable No. 65018).

e. Chemical Corps. Cobalt blue piped with golden yellow (cable Nos. 65011 and 65001).

f. Civil Affairs, USAR. Purple piped with white (cable Nos. 65009 and 65005).

g. Corps of Engineers. Scarlet piped with white (cable Nos. 65006 and 65005).

h. Military Police Corps. Green piped with yellow (cable Nos. 65007 and 65002).

i. Finance Corps. Silver gray piped with golden yellow (cable Nos. 65008 and 65001).

j. Infantry. Light blue (cable No. 65014).

k. Military Intelligence. Oriental blue piped with silver gray (cable Nos. 70209 and 65008).

l. Inspector General. Dark blue piped with light blue (cable Nos. 65012 and 65014).

m. Judge Advocate General's Corps. Dark blue piped with white (cable Nos. 65012 and 65005).

n. Army Medical Service. Maroon piped with white (cable Nos. 65017 and 65005).

o. National Guard Bureau. Dark blue (cable No. 65012).

p. Ordnance Corps. Crimson piped with yellow (cable Nos. 65013 and 65002).

q. Permanent professors of U.S. Military Academy. Scarlet piped with silver gray (cable Nos. 65006 and 65008).

r. Quartermaster Corps. Buff (cable No. 65015).

s. Signal Corps. Orange piped with white (cable Nos. 65004 and 65005).

t. Staff Specialist, USAR. Green (cable No. 65007).

u. Transportation Corps. Brick-red piped with golden yellow (cable Nos. 65020 and 65001).

v. Warrant officers. Brown (cable No. 65016).

w. Unassigned to branch. Teal blue piped with white (cable Nos. 70147 and 65005).

14-44. Lapel buttons of organization insignia. *a. Description.* Insignia of metal and enamel not exceeding $\frac{3}{4}$ -inch largest dimensions of U.S. Army units in any war.

b. How worn. Worn only on civilian clothes by personnel who served with such organizations during time of war.

14-45. Insignia for civilians. *a. Description.* For civilians accompanying U.S. Army forces in the field, an insignia conforming to the following specifications: on a khaki-colored cloth background $2\frac{1}{2}$ -inches in height and 3-inches in width, a dark blue equilateral triangle of $1\frac{1}{4}$ -inches, bearing the letters "US" in khaki color $\frac{1}{4}$ -inch in width and $\frac{1}{2}$ -inch in height (①, fig. 14-78). The insignia also will indicate the designated assign-

ment in dark blue letters ¼-inch in height, as indicated in figure 14-78.

(1) Designations authorized are as follows:

- (a) Scientific consultant.
- (b) Operations analyst.
- (c) War correspondent.
- (d) Technical observer.
- (e) Ordnance technician.
- (f) Chauffeur.
- (g) Messenger.

(2) Insignia for other civilians not named in (1) above, will conform to above description, except the insignia will not specify a particular designation (②, fig. 14-78).

b. *How worn.*

(1) On left breast pocket of outer garment or in a comparable position on outer garment having no pockets.

(2) On the left side of the garrison cap, centered on the curtain, 1 inch from front.

14-46. Distinctive items of uniform. a. *Purpose.* The distinctive items of uniform included in paragraphs 14-47 through 14-51 are designed to enhance the prestige of the Infantry soldier and to identify the combat ready Infantrymen assigned to Infantry units. Paragraph 14-52 pertains to distinctive items for troops of branches other than Infantry. These items are excepted from the provisions of paragraph 14-19.

b. *Training requirements.* The training requirements stated herein have reference to current Army training Programs.

14-47. Distinctive items authorized for Infantrymen. a. *Cord, shoulder* (①, fig. 14-79).

(1) *Description.* Shoulder cord of Infantry blue formed by a series of interlocking square knots around a center cord (①, fig. 14-79).

(2) *How worn.* On the outer garment (coat or shirt) of the summer and winter uniform, passed under the arm and over the right shoulder under the shoulder loop secured to the button of the loop (②, fig. 14-79).

(3) *By whom worn.* Officers and enlisted personnel of the Infantry who have been awarded the Combat Infantryman Badge, the Expert Infantryman Badge, or who have, as members of assigned In-

fantry units, successfully completed the basic unit phase of an Army Training Program or the equivalent thereof. Personnel who have completed, as a minimum, basic combat training, advanced individual training (or common specialist training) resulting in award of an MOS, and subsequently serve 1 year with an Infantry unit of regimental size or smaller are considered as having met the training requirement under the "equivalent thereof" provision.

(4) *When worn.* During the period of assignment to an Infantry regiment, brigade, separate Infantry battalion, Infantry company or Infantry platoon. (Personnel who are transferred from the unit will not be authorized to wear the shoulder cord until they are reassigned to an Infantry unit and fulfill requirements in (3) above except as provided in paragraph 14-50.

b. *Insignia disc, branch and "U.S."* (fig. 14-80).

(1) *Description.* Plastic disc of Infantry blue, 1¼ inches in diameter.

(2) *How worn.* On the summer and winter uniform, secured behind the branch and "U.S." insignia, leaving an exposed ⅛-inch rim around the insignia.

(3) *By whom worn.* Enlisted men of the Infantry.

(4) *When worn.*

(a) Upon completion of the advanced individual phase of the Infantry individual training program.

(b) Upon assignment to an Infantry TOE regiment or smaller Infantry unit, or to an Infantry table of distribution unit.

c. *Insignia disc, cap, service.*

(1) *Description.* Plastic disc of Infantry blue, 1¾ inches in diameter.

(2) *How worn.* Secured behind the insignia, cap, service.

(3) *By whom worn.* Enlisted men of the Infantry.

(4) *When worn.*

(a) Upon completion of the advanced individual phase of the Infantry individual training program.

- (b) Upon assignment to an Infantry TOE regiment or smaller Infantry unit, or to an Infantry table of distribution unit.

d. Scarf (fig. 14-80). Optional at the discretion of local commanders.

- (1) *Description.* Rayon scarf of Infantry blue. Of adopted design.
- (2) *How worn.* With the service, field or utility uniform, beneath the collar of the outer garment. When the scarf is prescribed, the detailed method of wearing the scarf will be as prescribed by major unit commanders.
- (3) *By whom worn.* Officers and enlisted men of the Infantry.
- (4) *Occasions for wear.*
 - (a) With service uniforms only for ceremonial type formations.
 - (b) With the field or utility uniform.

14-48. Distinctive items authorized for personnel en route to new assignment or assigned to medical installations for treatment. a. Upon reassignment an individual may continue to wear distinctive items authorized in paragraph 14-47 until reporting for duty at his new duty station, provided he was entitled to wear such items while assigned in his former unit.

b. During periods of assignment to medical installations for treatment an individual may retain and wear upon appropriate occasions the distinctive items authorized in paragraph 14-47, provided he was entitled to wear such items while assigned in his former unit.

14-49. Distinctive items authorized for personnel assigned to CONUS training divisions. Infantry trainees and cadre personnel assigned to division Artillery, division Artillery battalions, other separate battalions, and companies in CONUS training divisions who participate in Infantry training will wear the distinctive items of uniform prescribed in paragraph 14-47b and c and may wear the blue scarf prescribed in paragraph 14-47d provided the required individual training as prescribed for each item has been satisfactorily completed.

14-50. Authorization for award of distinctive items for Infantrymen. a. *All items except*

shoulder cord. CONUS army, MDW, and oversea major commanders are authorized to award items listed in paragraph 14-47.

b. *Shoulder cord.*

- (1) General officers commanding an organization normally commanded by a major general are authorized to award the shoulder cord to individuals successfully completing appropriate training. Individuals possessing the Combat Infantryman Badge or Expert Infantryman Badge will be awarded the shoulder cord upon assignment to an Infantry TOE unit. The shoulder cord will be presented at a suitable ceremony.
- (2) Oversea major commanders are authorized to award the shoulder cord, under such criteria as they may determine, consistent with this regulation.

14-51. Issue of distinctive items for infantrymen. Items listed in paragraph 14-47. will be issued without cost to enlisted men. The shoulder cord and scarf will be issued without cost to officers and warrant officers.

14-52. Distinctive items authorized for troops of branches other than Infantry. a. Scarf (fig. 14-80) optional at the discretion of local commanders.

- (1) *Description.* Rayon scarf of first named color of the branch (para 14-43). Of adopted design.
- (2) *How worn.* With the service, field or utility uniform, beneath the collar of the outer garment. When the scarf is prescribed, the detailed method of wearing the scarf will be as prescribed by major unit commanders.
- (3) *By whom worn.* Officers and enlisted men assigned to units or branches other than Infantry.
- (4) *Occasions for wear.*
 - (a) With service uniforms only for ceremonial type formations.
 - (b) With the field or utility uniform.

b. When prescribed, they will be provided enlisted personnel without cost to the individual (CTA 50-901).

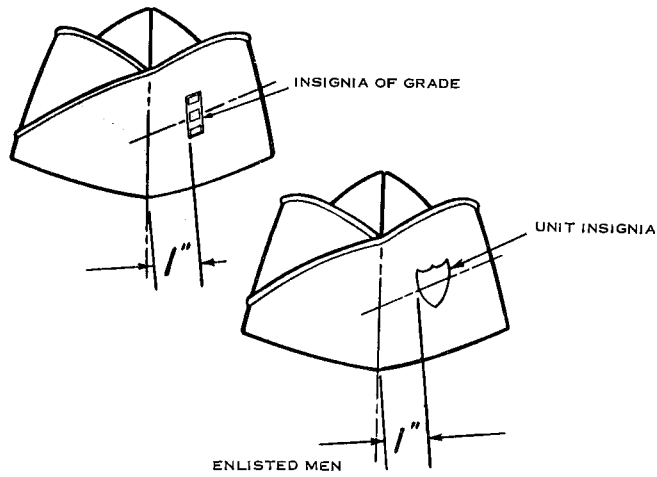

Figure 14-1. Insignia on garrison cap.



① Officers.



② Warrant officers.



③ Enlisted men.

Figure 14-2. Insignia on service cap.

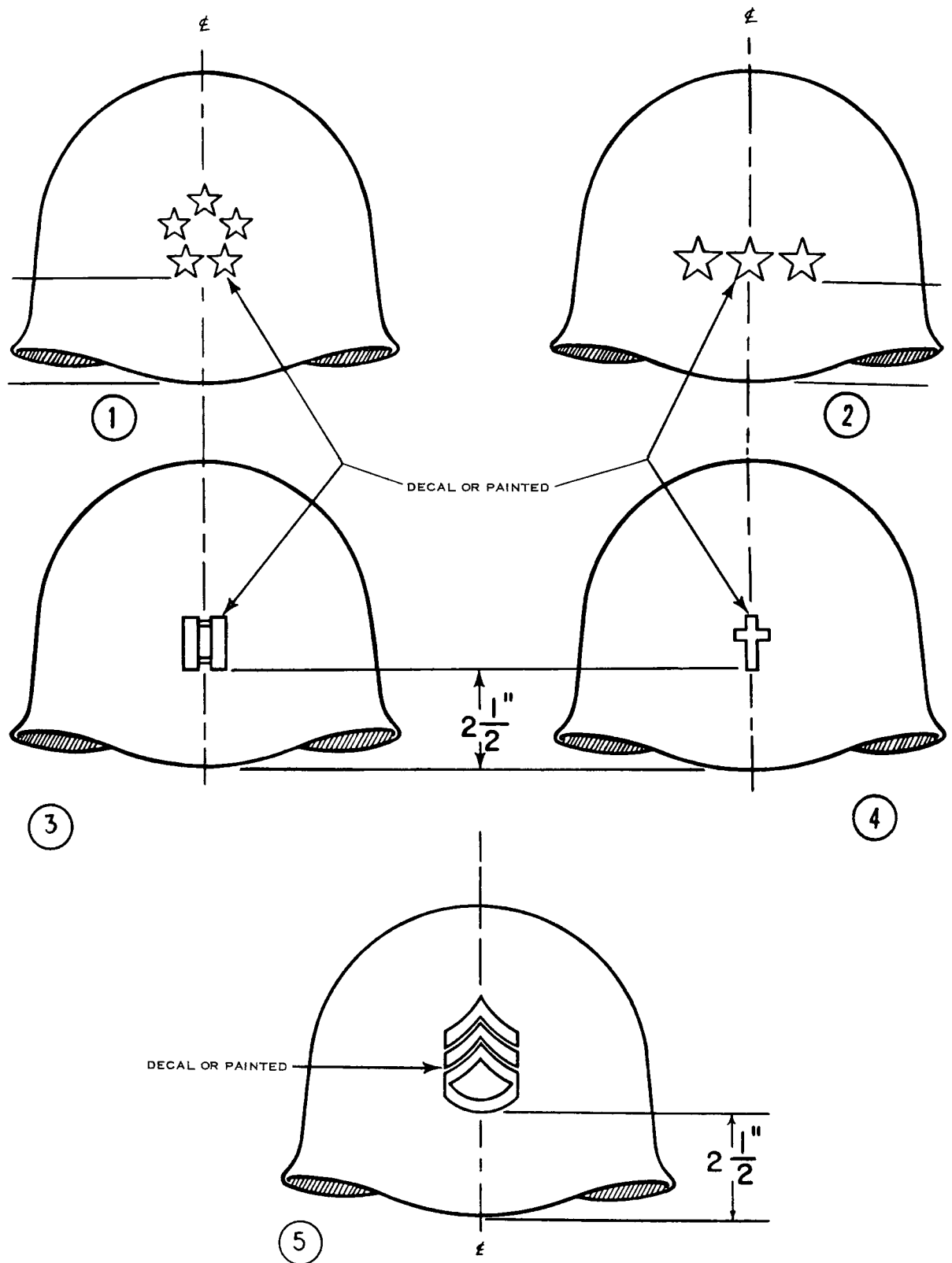

Figure 14-3. Helmet and helmet liner, insignia of grade and chaplains.

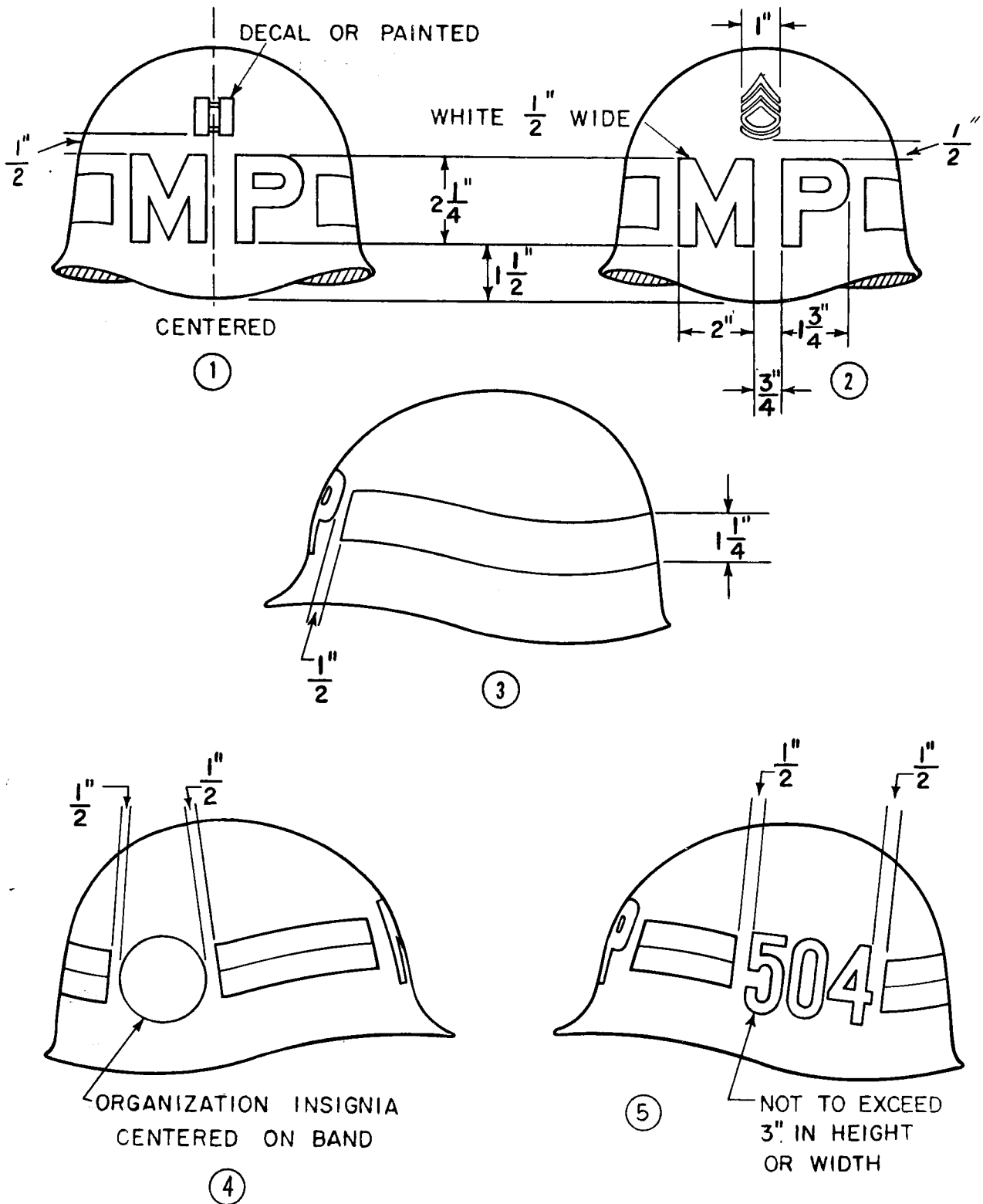

Figure 14-4. Helmet and helmet liner, military police.

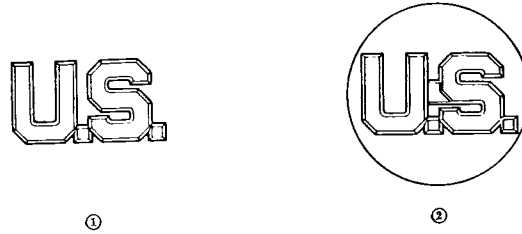

Figure 14-5. U.S. Insignia.

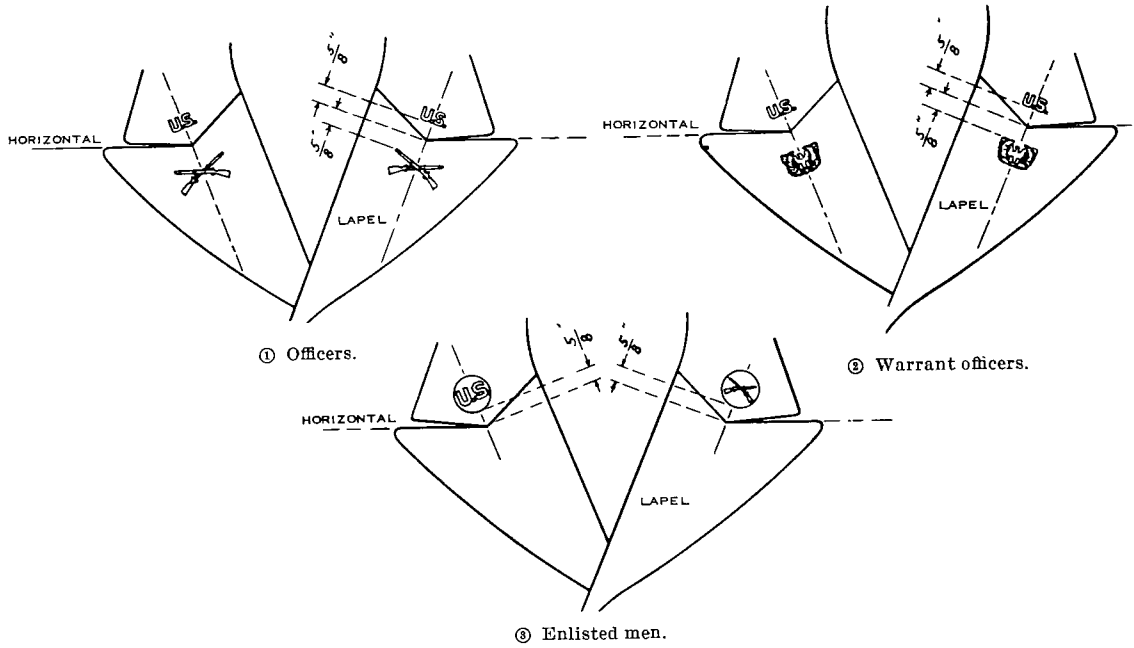

Figure 14-6. Insignia on lapels.

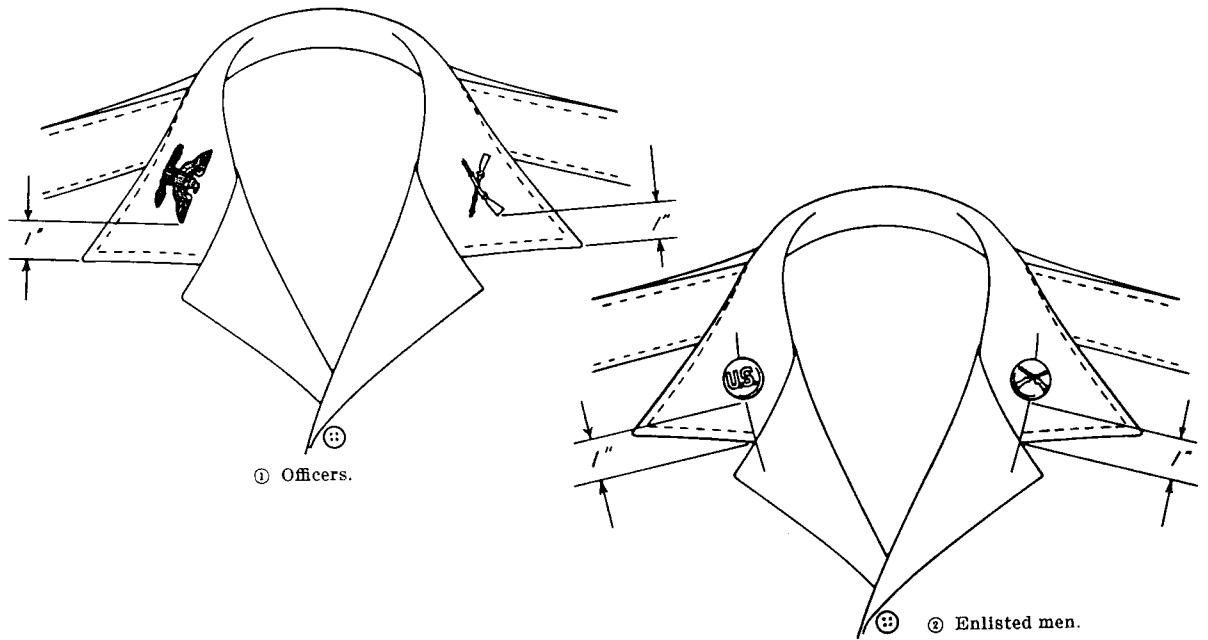
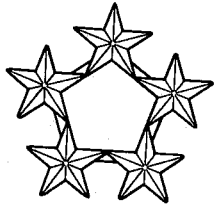
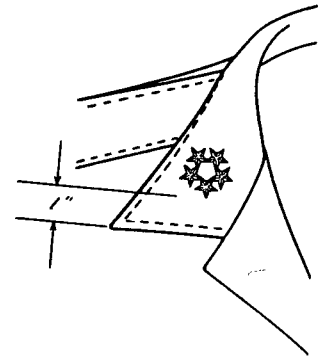

Figure 14-7. Insignia on collar of shirt.



① Insignia of grade, General of the Army.



③ Insignia on collar of shirt.

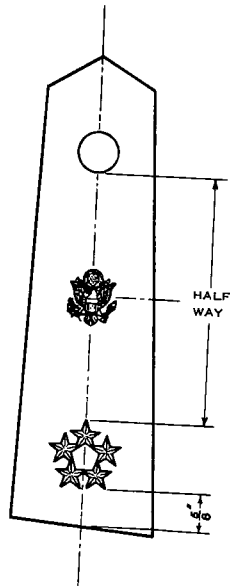

② Insignia on shoulder loops.

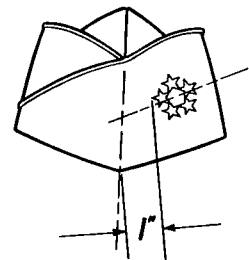

④ Insignia on garrison cap.

Figure 14-8. Insignia of grade, General of the Army.

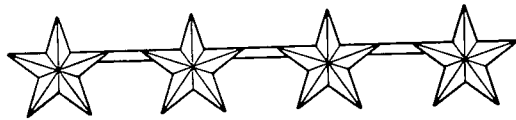

① Insignia of grade, General.

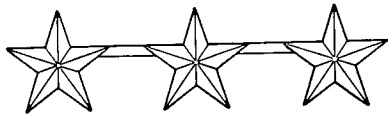

② Insignia of grade, Lieutenant General.

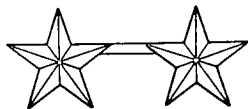

③ Insignia of grade, Major General.



④ Insignia of grade, Brigadier General.

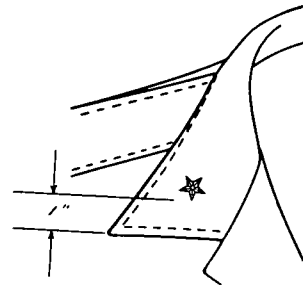
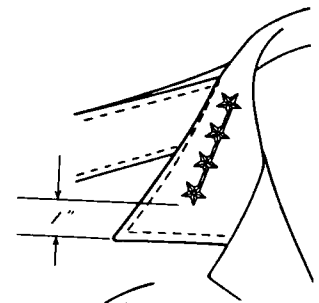

⑤ Insignia of collar of shirt.

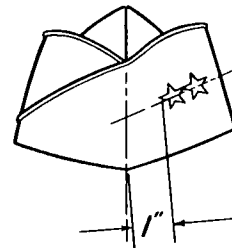

⑥ Insignia on garrison cap.

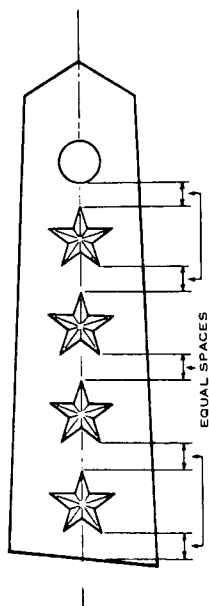

⑦ General.

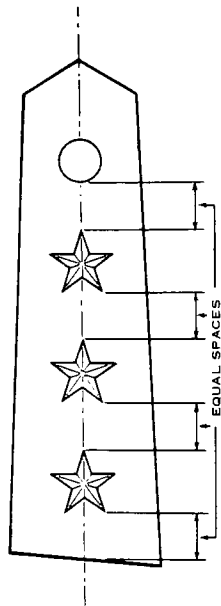

⑧ Lieutenant General.

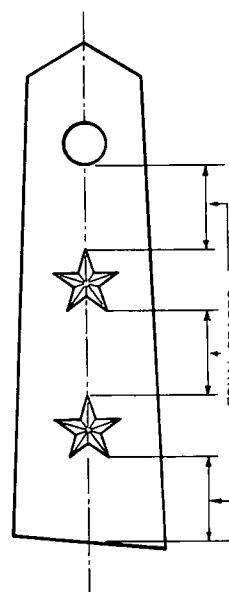

⑨ Major General.

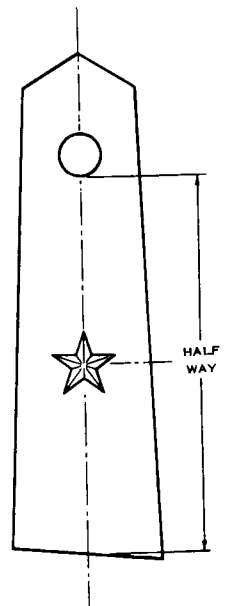

⑩ Brigadier General.

Figure 14-9. Insignia of grade, General officers.



Insignia of grade, Colonel.

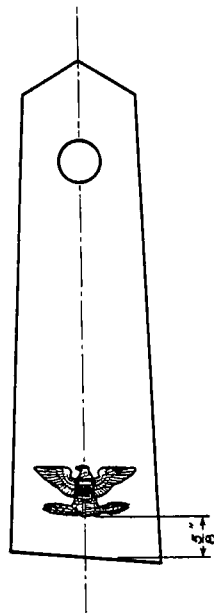

Insignia on shoulder loops

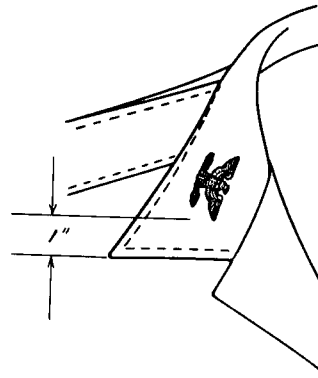

Insignia on collar of shirt

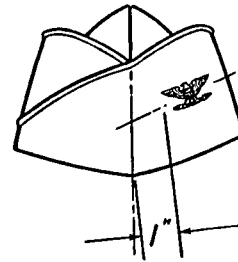

Insignia on garrison cap

Figure 14-10. Insignia of grade, Colonel.

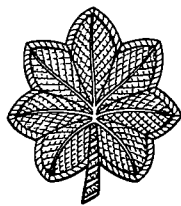

Insignia of grade, Lt. Colonel, Major

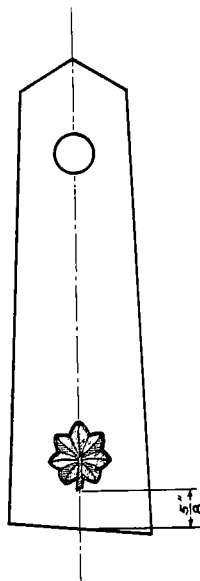

Insignia on shoulder loops

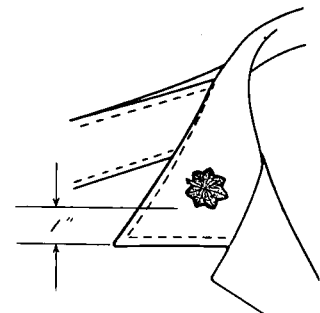

Insignia on collar of shirt

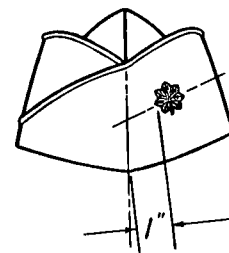

Insignia on garrison cap

Figure 14-11. Insignia of grade, Lt. Colonel and Major.

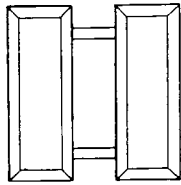

Insignia of grade, Captain

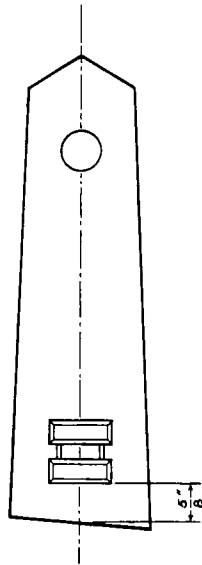

Insignia on shoulder loops

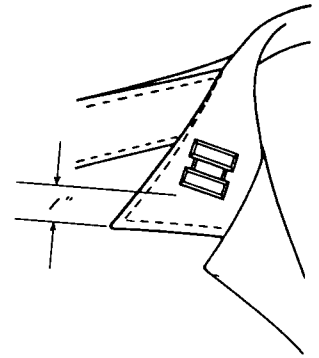

Insignia on collar of shirt

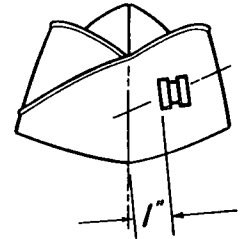

Insignia on garrison cap

Figure 14-12. Insignia of grade, Captain.

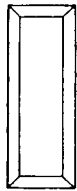

Insignia of grade, 1st & 2nd Lieutenant

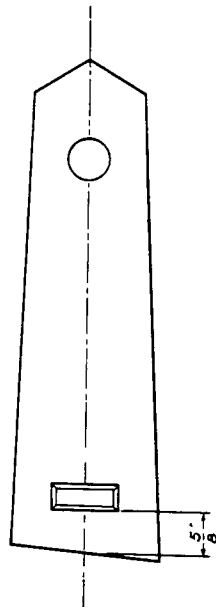

Insignia on shoulder loops

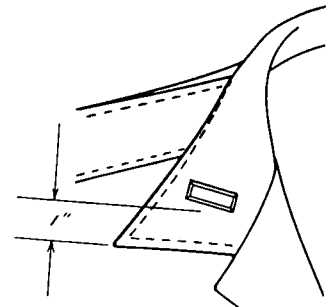

Insignia on collar of shirt

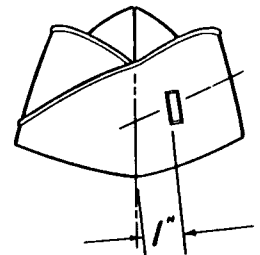

Insignia on garrison cap

Figure 14-13. Insignia of grade, Lieutenant.

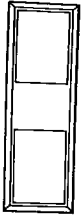

Insignia of grade, Warrant officer grades 1 and 3

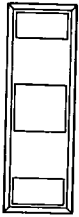

Insignia of grade Warrant officers grades 2 and 4

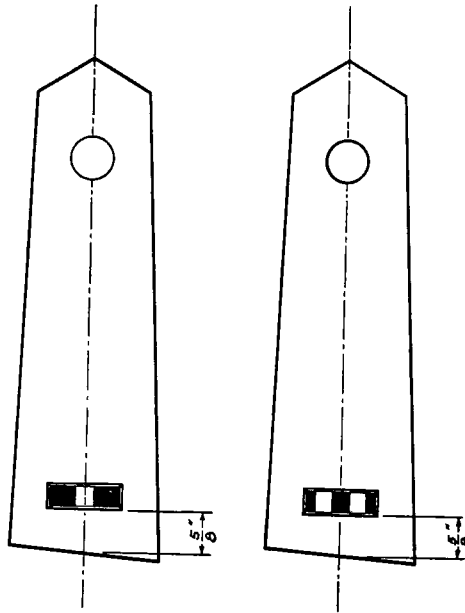

Insignia on shoulder loops

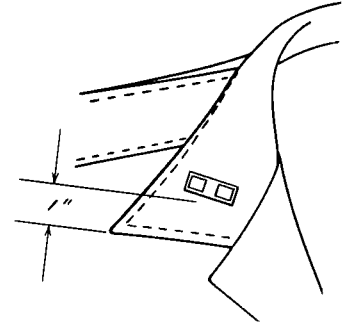

Insignia on collar of shirt

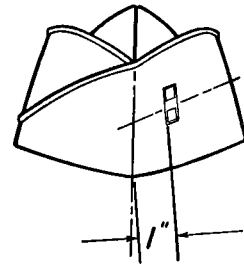

Insignia on garrison cap

Figure 14-14. Insignia of grade, Warrant officers.

O.C.S.

① Officer candidate insignia.

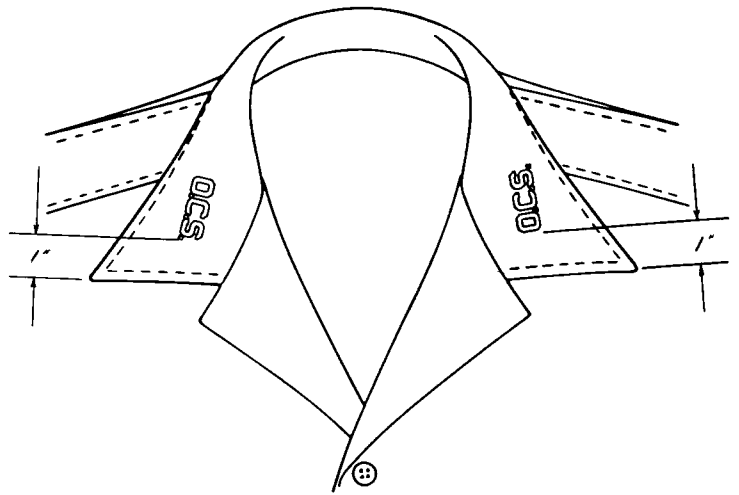

③ Insignia on collar of shirt.

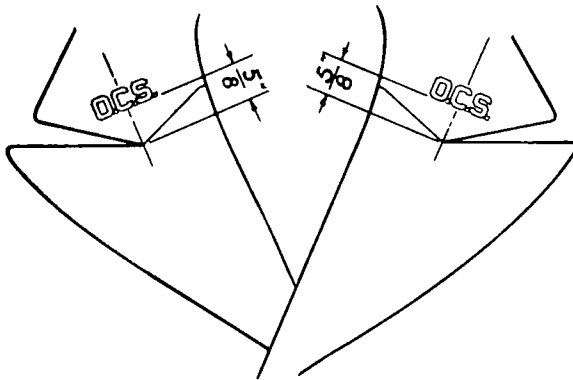

② Insignia on lapels.

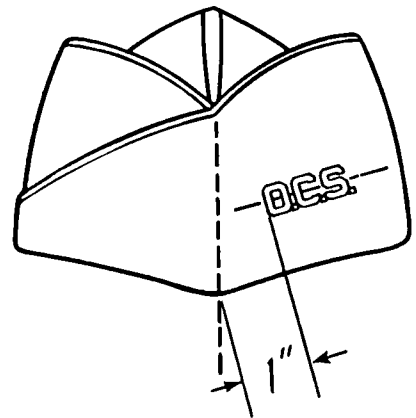

④ Insignia on garrison cap.

Figure 14-15. Insignia for officer candidates.

W.O.C.

Figure 14-16. Insignia for Warrant officer candidates.

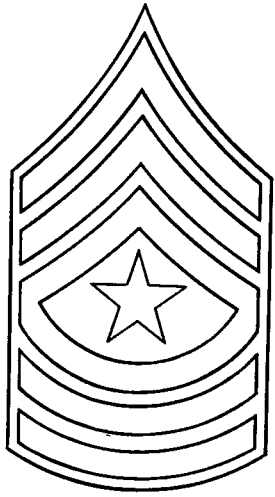

①

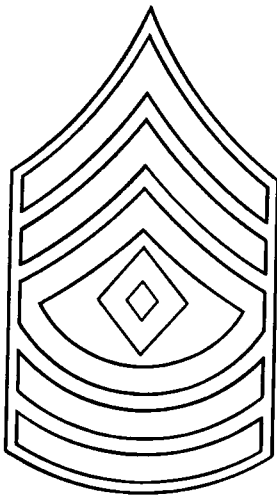

②

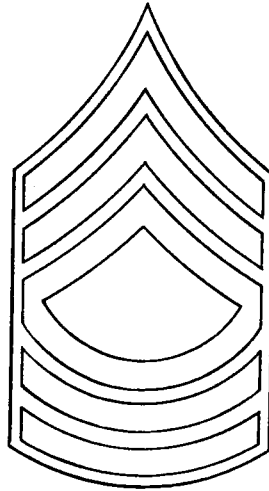

③

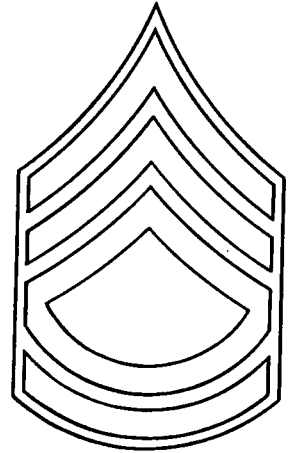

④

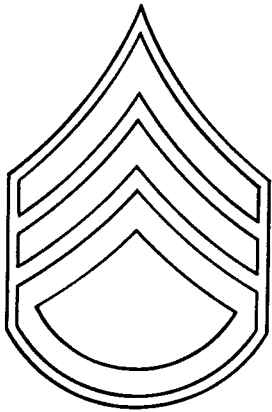

⑤

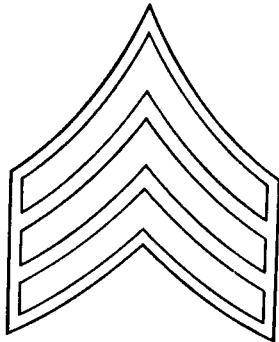

⑥

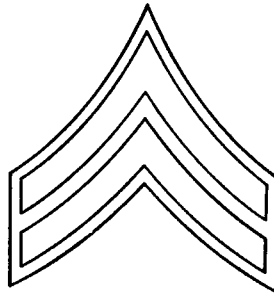

⑦

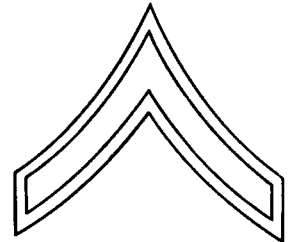

⑧

Figure 14-17. Insignia of grade, enlisted personnel.

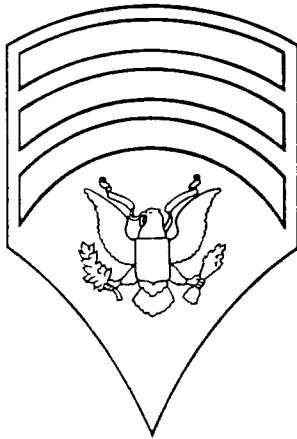

① Specialist Seven (E-7)

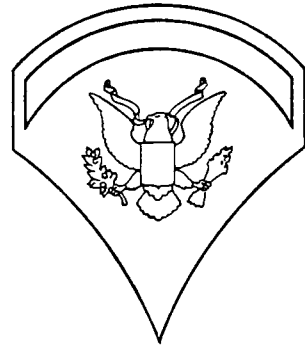

③ Specialist Five (E-5)

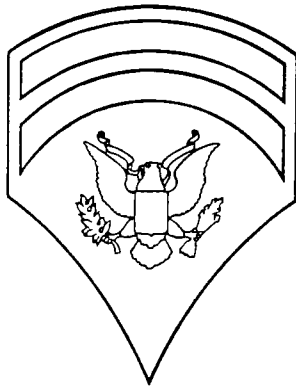

② Specialist Six (E-6)

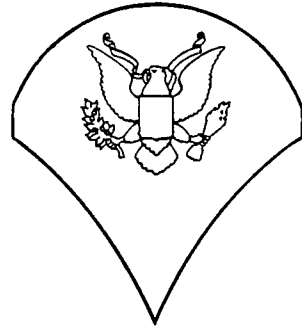

④ Specialist Four (E-4)

Figure 14-18. Insignia of grade for enlisted personnel, Army specialists.

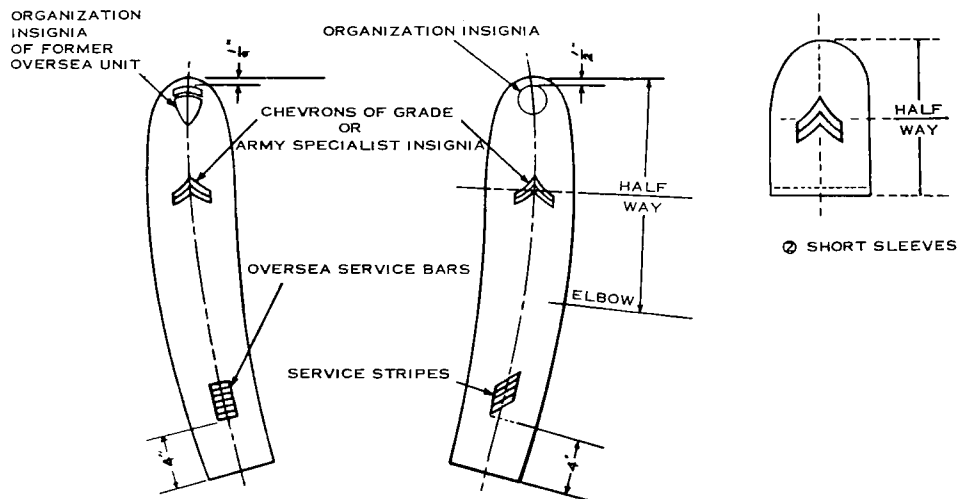
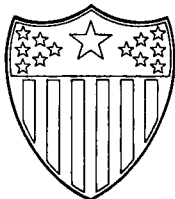
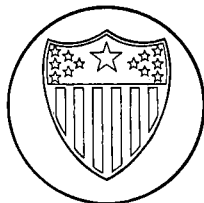

Figure 14-19. Wearing insignia on sleeve, enlisted personnel.



① Officer.



② Enlisted personnel.

Figure 14-20. Adjutant General's Corps.

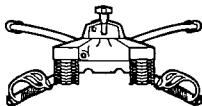

① Officer.

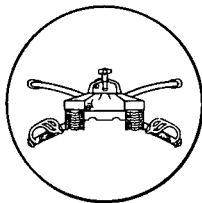

② Enlisted personnel.

Figure 14-21. Armor.



① Dental corps.



② Medical corps.



③ Medical Service corps.



④ Veterinary corps.



⑤ Army Nurse corps.



⑥ Army Medical Specialist corps.



⑦ Enlisted personnel.

Figure 14-22. Army Medical service.

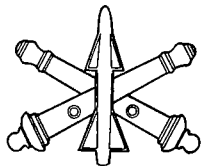

① Officer.

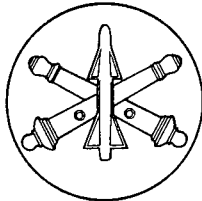

② Enlisted personnel.

Figure 14-23. Artillery.



Figure 14-24. Unassigned to branch, enlisted personnel.

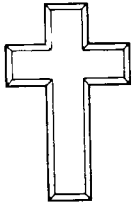

① Christian.

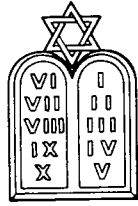

② Jewish.

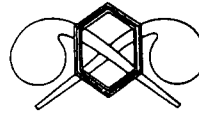

① Officer.

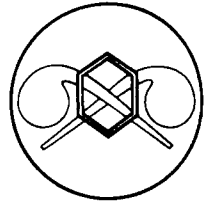

② Enlisted personnel.

Figure 14-25. Chaplains.

Figure 14-26. Chemical Corps.



① Officer.

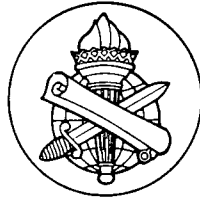

② Enlisted personnel.

Figure 14-27. Civil Affairs, USAR.



① Officer.

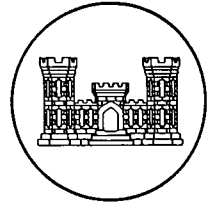

② Enlisted personnel.

Figure 14-28. Corps of Engineers.

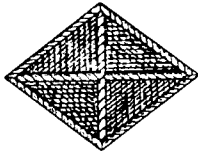

① Officer.

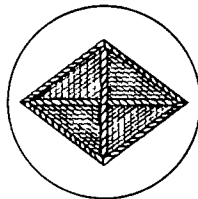

② Enlisted personnel.

Figure 14-29. Finance Corps.

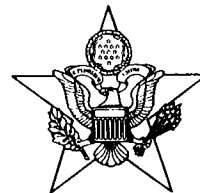
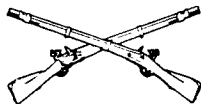
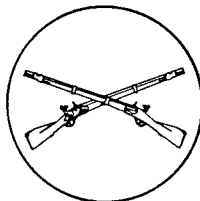

Figure 14-30. General Staff, officers.



① Officer.



② Enlisted personnel.

Figure 14-31. Infantry.

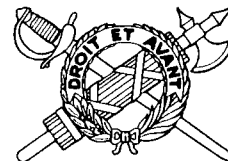
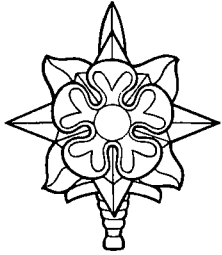
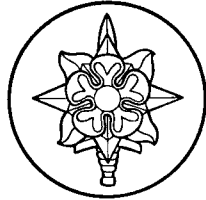

Figure 14-32. Inspector General, officers.



① Officer.



② Enlisted personnel.

Figure 14-33. Military Intelligence.



① Officer.



② Enlisted personnel.

Figure 14-38. Quartermaster Corps.



① Officer.



② Enlisted personnel.

Figure 14-34. Judge Advocate General's Corps.

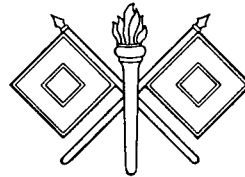

① Officer.

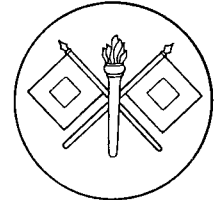

② Enlisted personnel.

Figure 14-39. Signal.

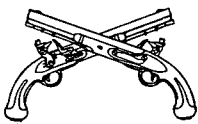

① Officer.

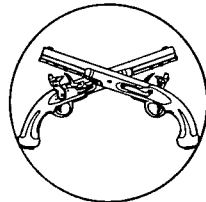

② Enlisted personnel.

Figure 14-35. Military Police Corps.



Figure 14-40. Staff Specialist, USAR, officers.



Figure 14-36. National Guard Bureau, officers.

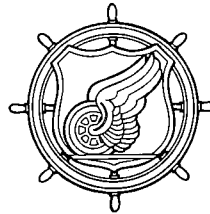

① Officer.

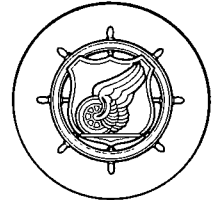

② Enlisted personnel.

Figure 14-41. Transportation Corps.



① Officer.

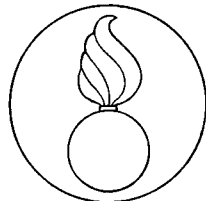

② Enlisted personnel.

Figure 14-37. Ordnance.

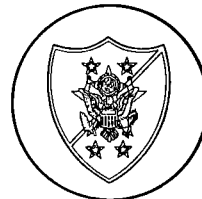

Figure 14-42. The Sergeant Major of the United States Army.



Figure 14-43. Warrant officers.



Figure 14-47. Aides to Chief of Staff.

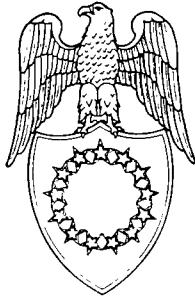

Figure 14-44. Aides to President of United States.

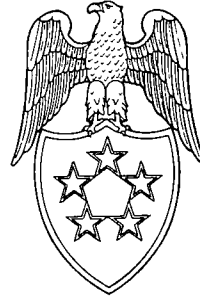

Figure 14-48. Aides to General of Army.

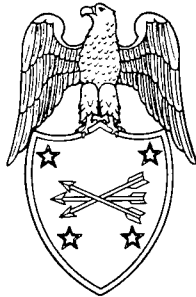

Figure 14-45. Aides to Secretary of Defense.

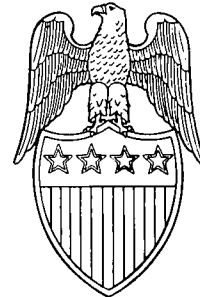

Figure 14-49. Aides to General.

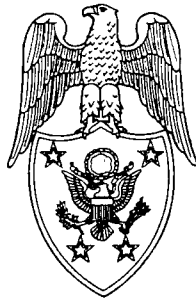

Figure 14-46. Aides to Secretary of Army and Under Secretary of Army.

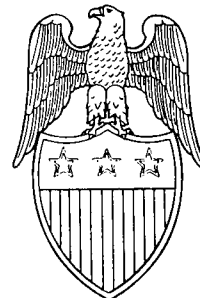

Figure 14-50. Aides to Lieutenant General.

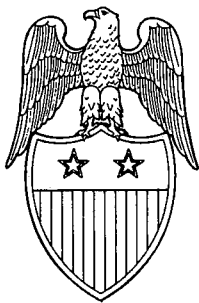

Figure 14-51. Aides to Major General.

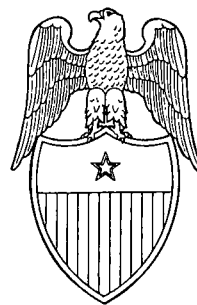

Figure 14-52. Aides to Brigadier General.

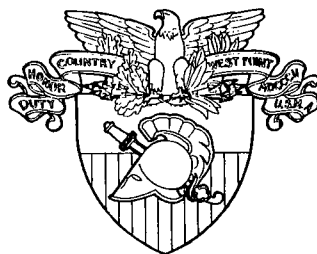

Figure 14-53. Permanent professors, registrars, and civilian instructors, U.S. Military Academy.

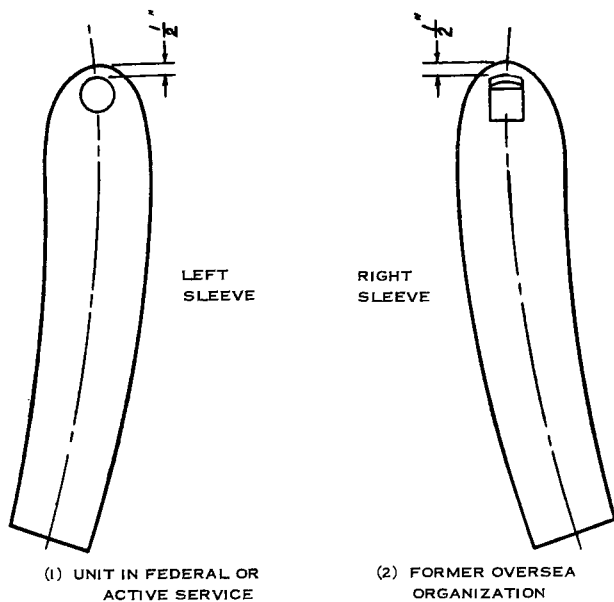

Figure 14-54. Organization shoulder sleeve insignia.

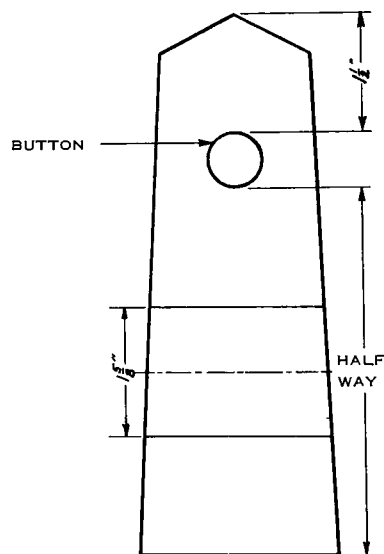

Figure 14-55. Combat leader's identification.

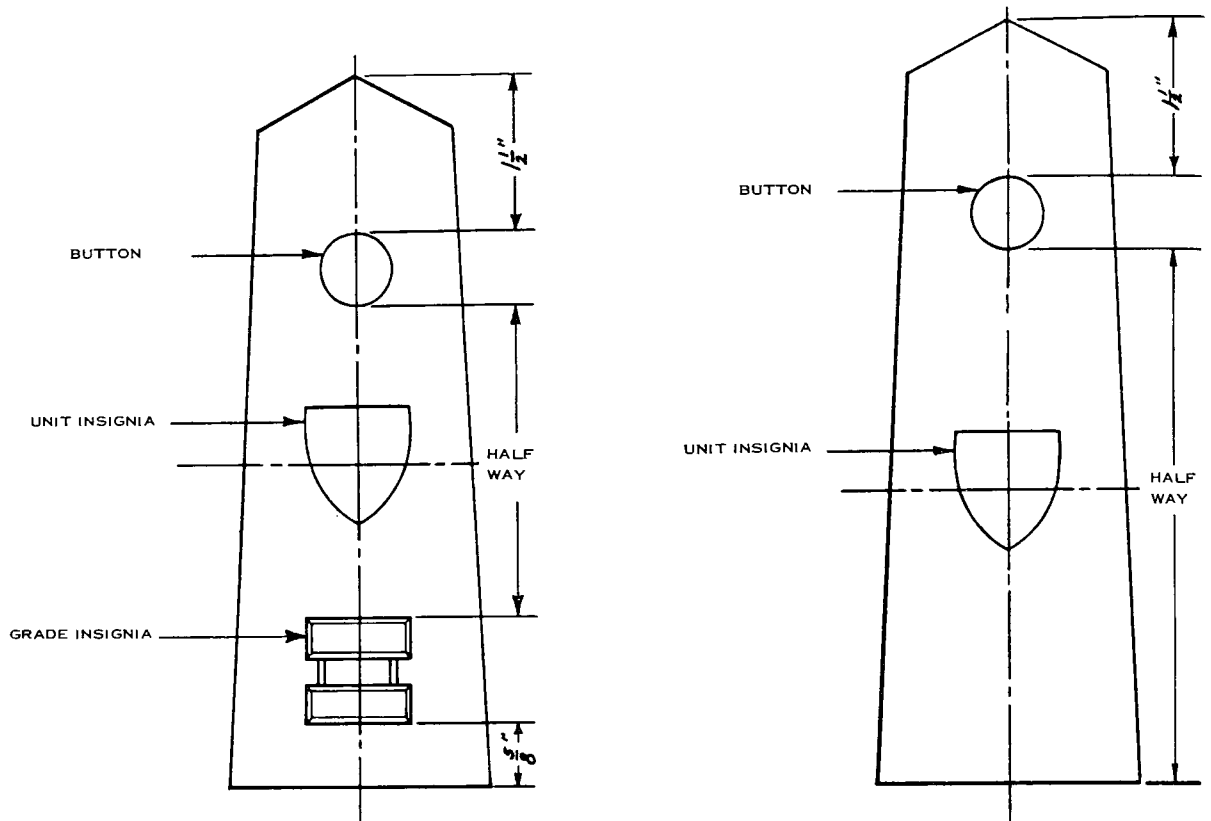
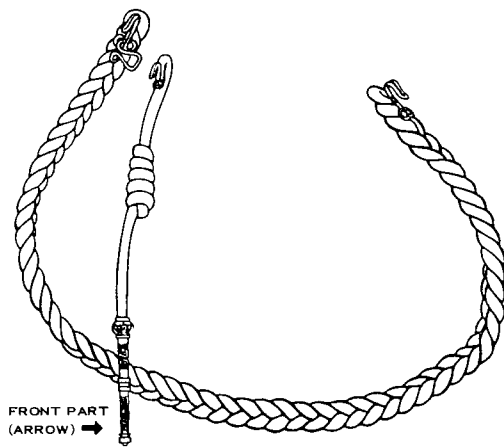
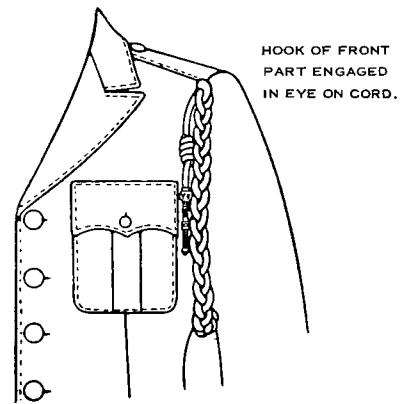

Figure 14-56. Wear of Distinctive insignia.



① Front part (arrow).



② Hook of front part engaged in eye of cord.

Figure 14-57. Aiguillette, service.

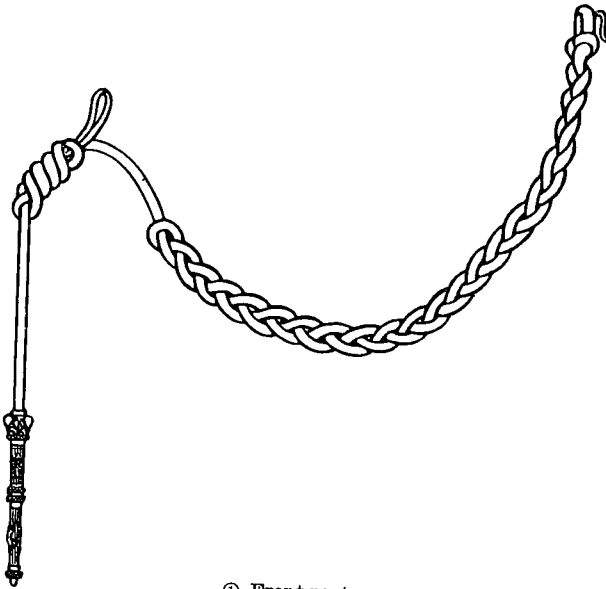

① Front part.

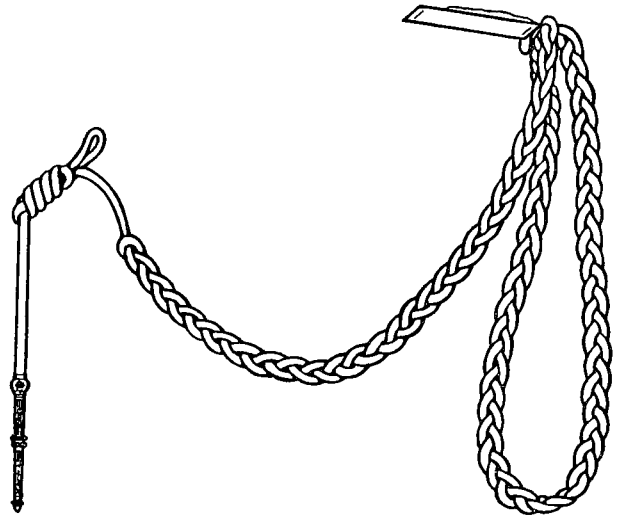

② Back part with brass strip and shoulder loop.

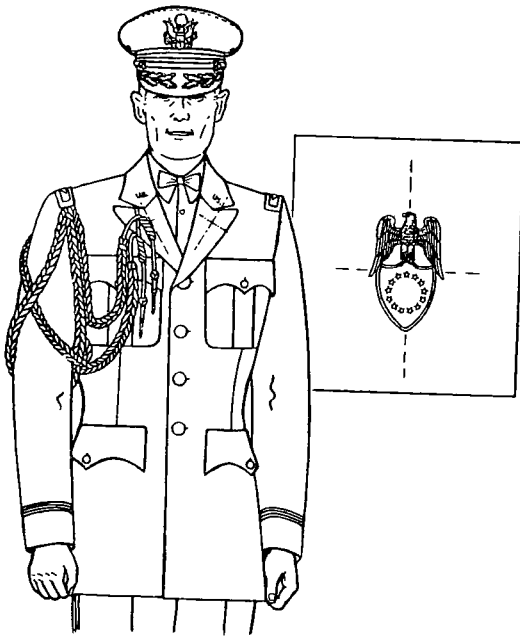

③ Presidential aides.

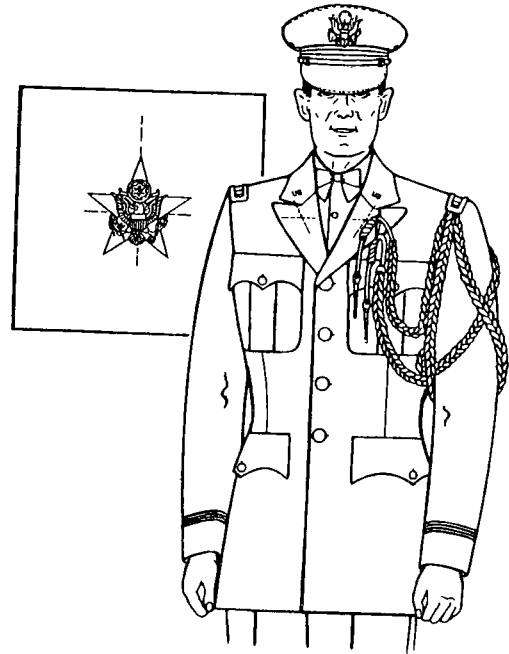

④ Officers regularly detailed on the Army General Staff, Army Attachés, and other aides.

Figure 14-58. Aiguillette, dress.

U.S. ARMY

Figure 14-59. Insignia, distinguishing, U.S. Army.

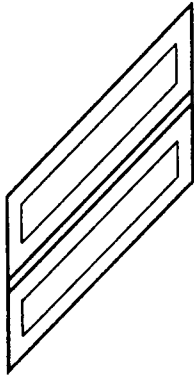

Figure 14-60. Service stripes.

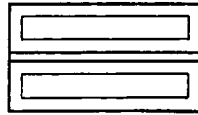

Figure 14-61. Oversea service bars.

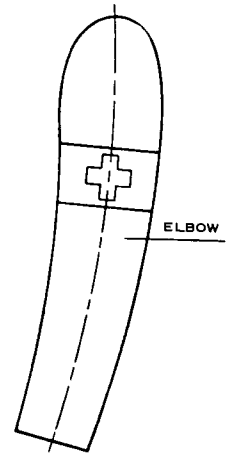
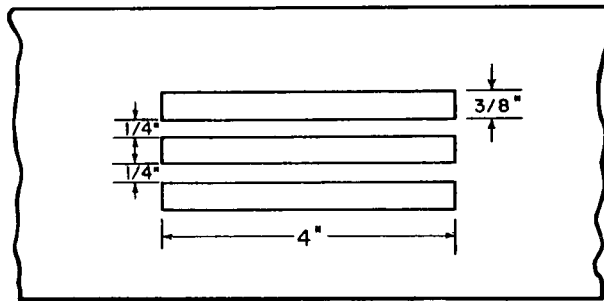
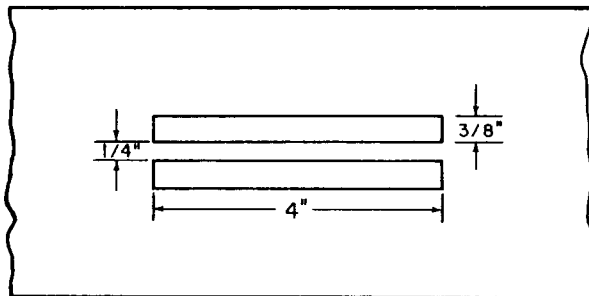

Figure 14-62. Brassards.



① Captain.



② First lieutenant.

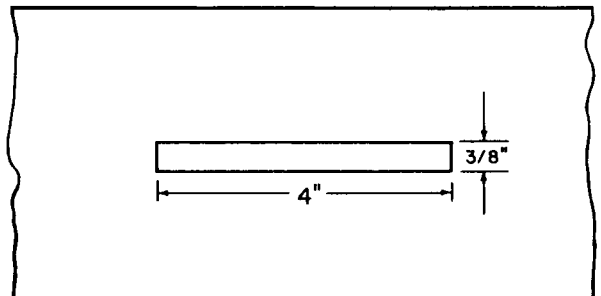

③ Second lieutenant.

Figure 14-63. Acting officers brassard.

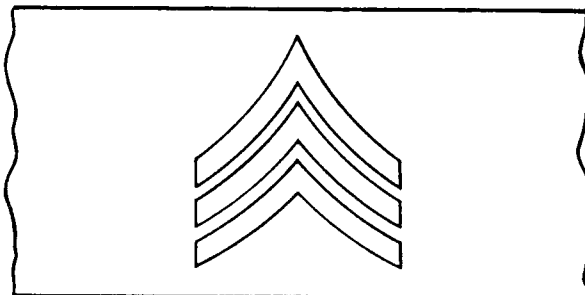

① Sergeant.

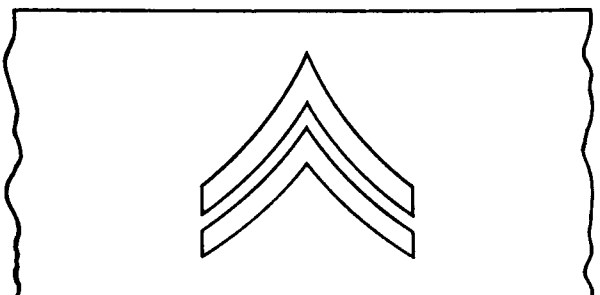

② Corporal.

Figure 14-64. Acting noncommissioned officers brassard.

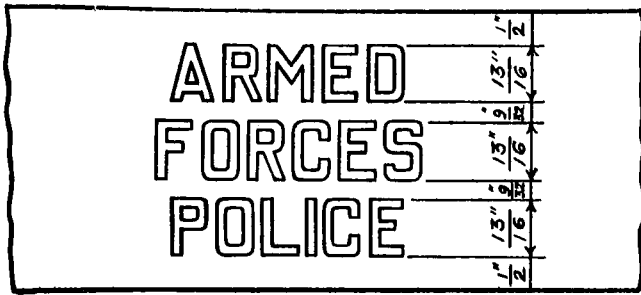

Figure 14-65. Armed Forces Police brassard.

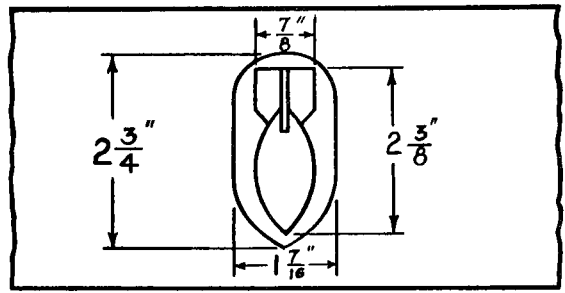

Figure 14-66. Explosive ordnance disposal brassard.

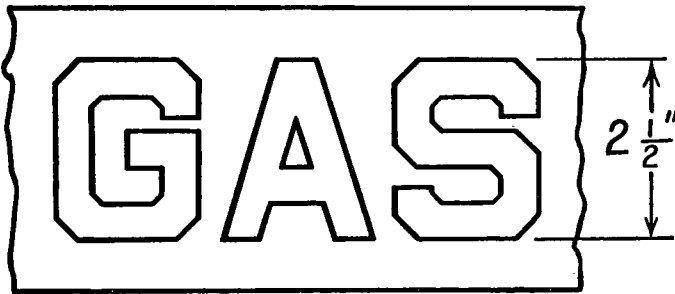

Figure 14-67. Gas brassard.

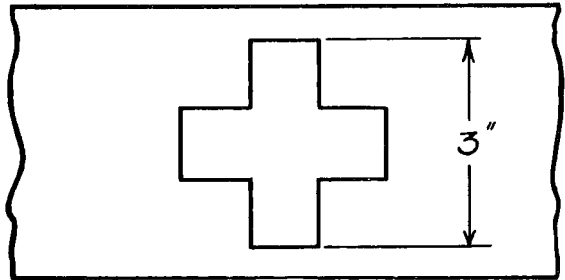

Figure 14-68. Geneva Convention brassard.

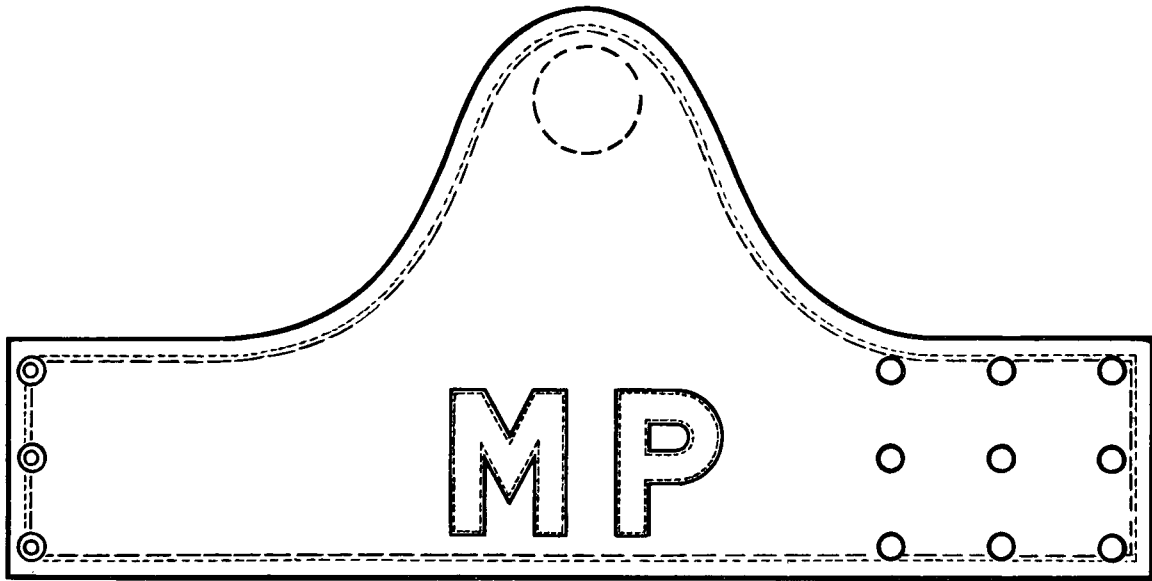

Figure 14-69. Military Police brassard.

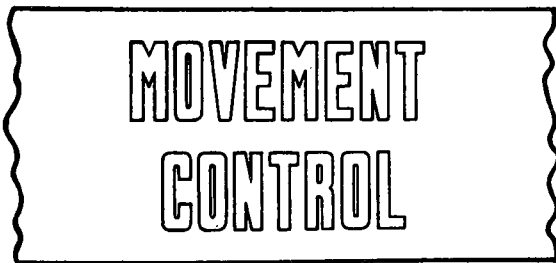

Figure 14-70. Movement control brassard.



Figure 14-71. Officer of Guard brassard.

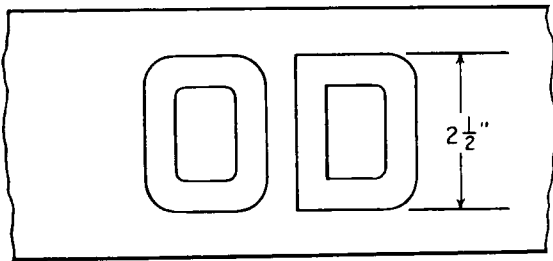

Figure 14-72. Officer of Day brassard.

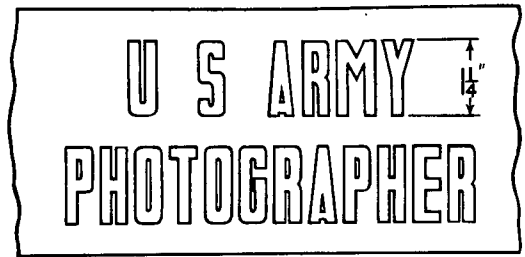

Figure 14-73. Photographer brassard.

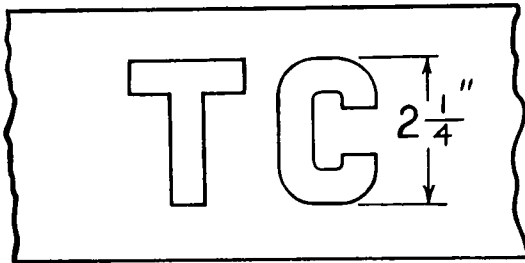

Figure 14-74. Port brassard.

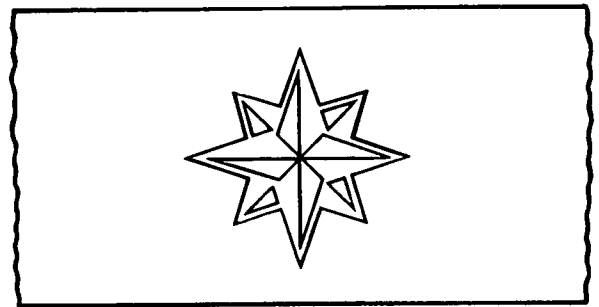

Figure 14-75. Trainees in leadership courses brassard.

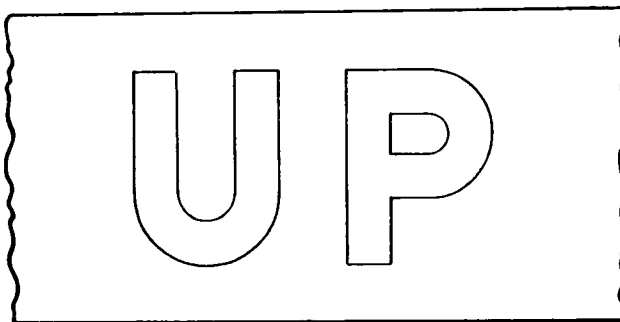

Figure 14-76. Unit police brassard.

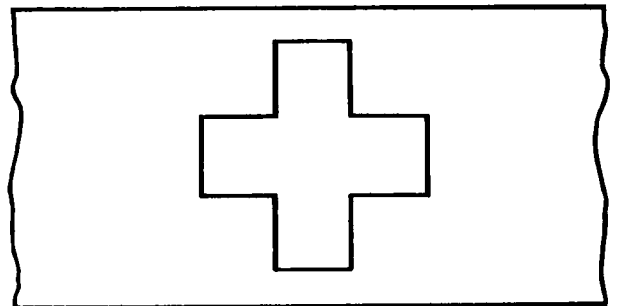
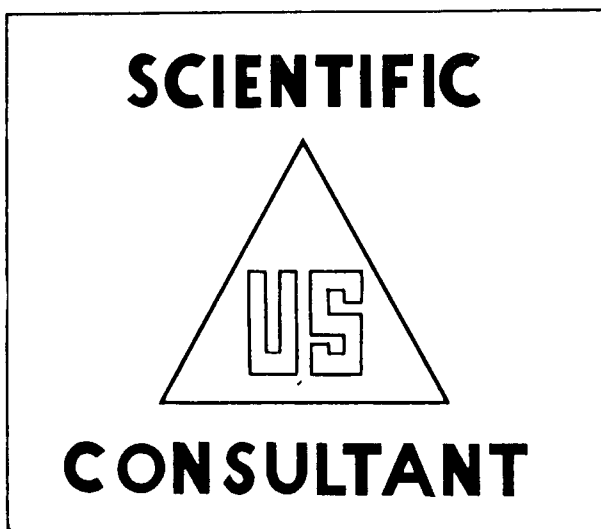
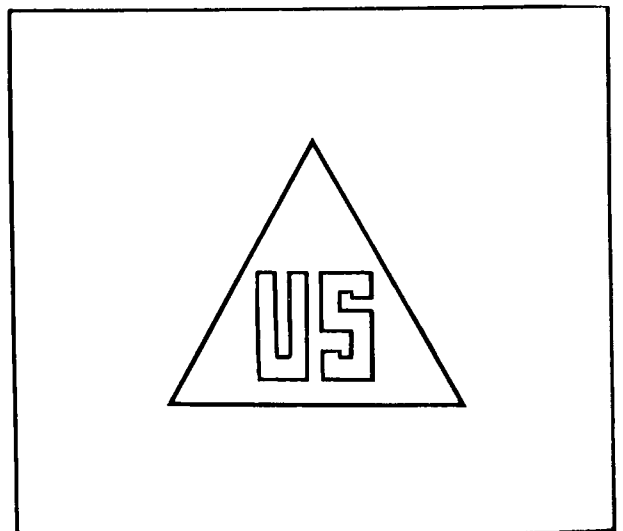

Figure 14-77. Veterinary corps brassard.



①



②

Figure 14-78. Insignia for civilians.

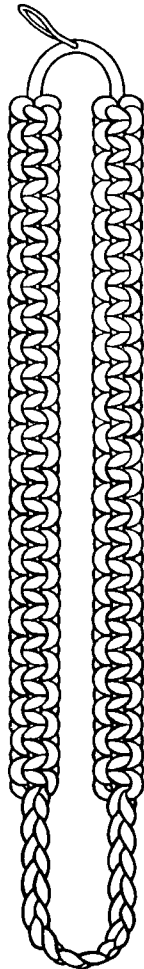

①

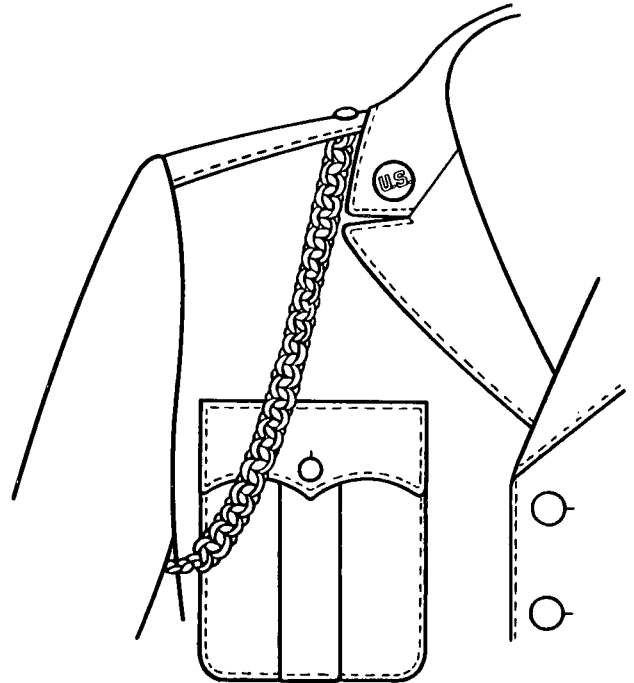

②

Figure 14-79. Cord, shoulder, infantrymen.

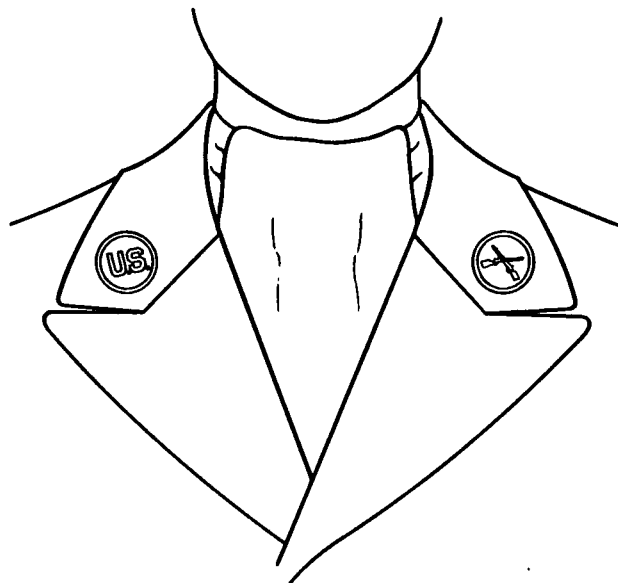

Figure 14-80. Insignia disc, Branch and U.S.



APPENDIX A COMPOSITION OF UNIFORMS

Item	Army Green uniform (chap. 7)	Army Blue uniform (chap. 9)		Army Tan uniform (chap. 6)	Army Khaki uniform (conventional) (chap. 5)	Army Khaki uniform (abbreviated) (chap. 5)	Army White uniform (chap. 8)	Army White Mess uniform (chap. 10)	Army Blue Mess uniform (chap. 11)	Army Evening Dress uniform (chap. 12)
		Officers and warrant officers	Enlisted men							
1. Aiguillette, dress (para 14-21)		X					X	X	X	X
2. Aiguillette, service (para 14-20)	X	X		X	X		X			
3. Badges, full size (see AR 672-5-1)	X	X	X	X	X	X	X			
4. Badges, miniature (see AR 672-5-1)		X	X				X	X	X	X
5. Belt, waist (para 13-1)	X	X	X	X	X	X	X			
6. Beret, rifle green (para 13-2)	X			X	X	X				
7. Boot, combat (para 4-3)	X			X		X				
8. Cap, garrison, Army Green (para 7-7a)	X			X	X	X				
9. Cap, service, Army Green (para 7-7b)	X			X	X	X				
10. Cap, Army Blue (para 9-7)		X	X						X	X
11. Cap, Army White (para 8-7)							X	X		
12. Cape, Blue (para 13-4)		X							X	X
13. Coat, Army Green (para 7-5)	X									
14. Coat, Army Tan (para 6-5)				X						
15. Coat, Army Blue (para 9-5)		X	X							
16. Coat, Army Evening Dress (para 12-5)										X
17. Coat, Army White (para 8-5)							X			
18. Collar, wing (para 13-5)								X	X	X
19. Collar, turndown (para 13-5)		X	X				X	X	X	
20. Cord, shoulder, Infantry (para 14-47a)	X	X	X	X	X	X	X			
21. Cuff links, gold (para 13-19b(2)(3))		X	X				X	X	X	
22. Cuff links, white (para 13-19b(1))										X
23. Cummerbund (para 10-7b and 11-7b)								X	X	
24. Decorations, full size or ribbons (see AR 672-5-1)	X	X	X	X	X	X	X			
25. Decorations, miniature (see AR 672-5-1)		X	X				X	X	X	X
26. Distinctive insignia (para 14-19)	X			X	X	X				
27. Fourragere (see AR 672-5-1)	X	X	X	X	X	X	X	X	X	X
28. Gloves, black (para 13-7a)	X									
29. Gloves, white (para 13-7b)		X	X				X	X	X	X
30. Identification, General Staff (see AR 672-5-1)	X	X		X	X	X	X	X	X	X
31. Identification, Department of Defense (see AR 672-5-1)	X	X	X	X	X	X	X	X	X	X
32. Jacket, Army Blue Mess (para 11-5)									X	
33. Jacket, Army White Mess (para 10-5)								X		
34. Medals, service, full size or ribbons (see AR 672-5-1)	X	X	X	X	X	X	X			
35. Medals, service, miniature (see AR 672-5-1)		X	X			X	X	X	X	

APPENDIX A—Continued
COMPOSITION OF UNIFORMS—Continued

Item	Army Green uniform (chap. 7)	Army Blue uniform (chap. 9)		Army Tan uniform (chap. 6)	Army Khaki uniform (conventional) (chap. 5)	Army Khaki uniform (abbreviated) (chap. 5)	Army White uniform (chap. 8)	Army White Mess uniform (chap. 10)	Army Blue Mess uniform (chap. 11)	Army Evening Dress uniform (chap. 12)
		Officers and warrant officers	Enlisted men							
36. Necktie, four-in-hand, black (para 13-10)	X	X	X	X			X			
37. Necktie, bow, black (para 13-10)		X	X				X	X	X	
38. Necktie, bow, white (para 13-10c)										X
39. Overcoat, Army Green (para 13-11a)	X	X	X						X	
40. Overcoat, olive green (para 13-11b)	X									
41. Overcoat, taupe (para 13-11c)	X	X	X						X	
42. Raincoat (para 13-13)	X	X	X	X	X	X	X	X	X	X
43. Scarf, Army Green (para 13-14a)	X									
44. Scarf, distinctive branch (para 14-47d and 14-52a)	X			X	X	X				
45. Scarf, olive drab (para 13-14b)										
46. Scarf, white (para 13-14c)		X	X						X	
47. Shirt, Army Khaki (para 5-6)					X	X				
48. Shirt, Army Tan (para 6-7)				X						
49. Shirt, tan, Army shade 446 or 46 (para 13-15a and c)	X			X						
50. Shirt, white (para 13-15d)		X	X				X			
51. Shirt, white, evening dress (para 13-15f)								X	X	
52. Shirt, white, full dress (para 13-15e)								X	X	X
53. Shoes, low quarter (para 13-16)	X	X	X	X	X	X	X	X	X	X
54. Shorts, Army Khaki (para 5-7)						X				
55. Shoulder knots (para 13-17)								X	X	X
56. Socks, black (para 13-18)	X	X	X	X	X		X	X	X	X
57. Socks, sand, knee-length (para 5-4b and 5-9)						X				
58. Studs, gold color (para 13-19)								X	X	
59. Studs, white (para 13-19)										X
60. Trousers, Army Blue (para 9-6)		X	X							
61. Trousers, Army Blue Mess (para 11-6)		X							X	
62. Trousers, Army Evening Dress (para 12-6)										X
63. Trousers, Army Green (para 7-6)	X									
64. Trousers, Army Khaki (para 5-5)					X					
65. Trousers, Army Tan (para 6-6)				X						
66. Trousers, Army White (para 8-6)							X			
67. Trousers, black dress (para 10-6)								X		
68. Vest, white (para 10-4c; 10-7a, 11-4c, 11-7, 12-4b, and 12-7)								X	X	X

APPENDIX B

U.S. ARMY CLOTHING ALLOWANCE ZONES

(Narrative description of zones contained in CTA 50-901)

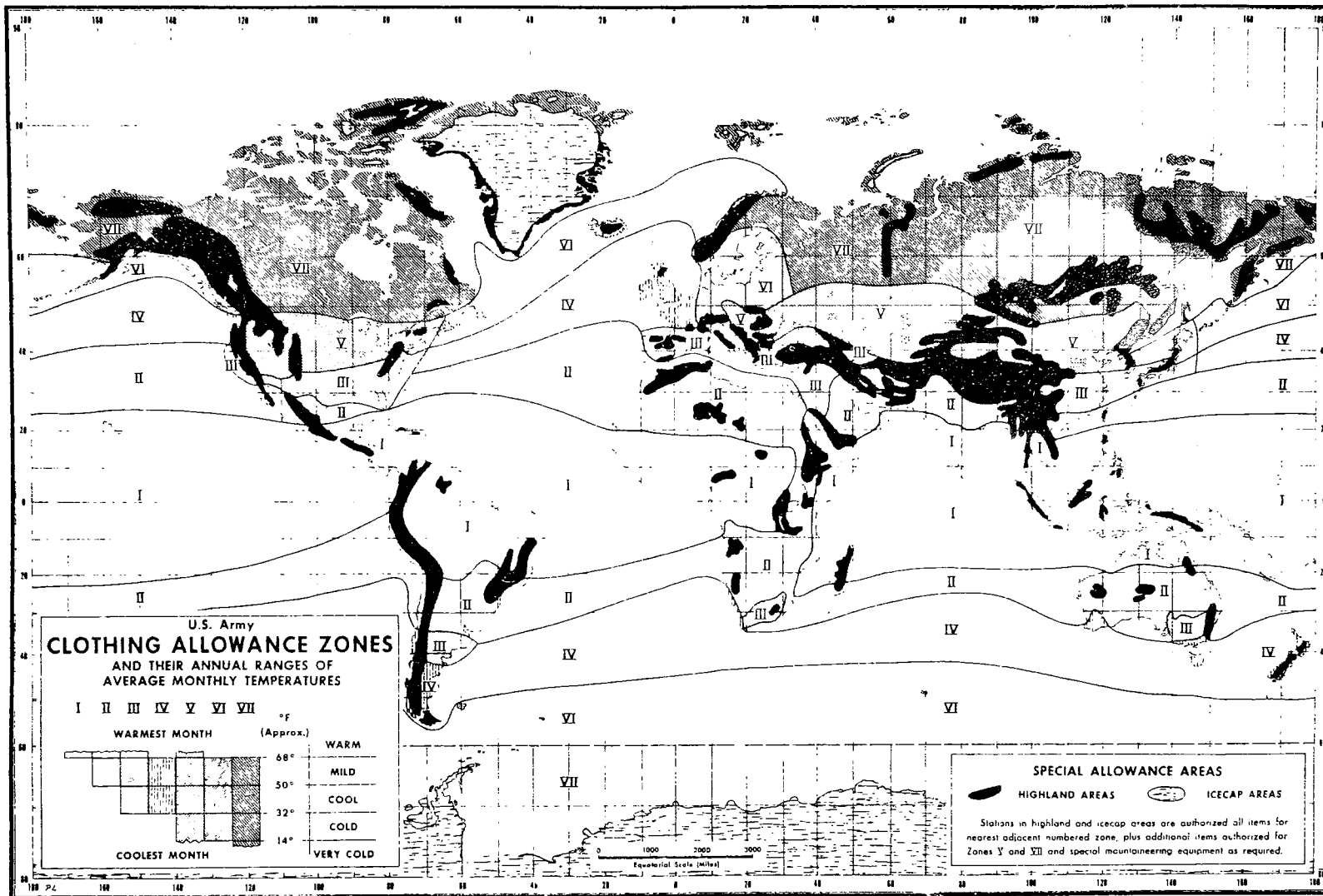



The proponent of this regulation is HQ. U.S. Army Materiel Command. Users are invited to send comments and suggested improvements to Commanding General, U.S. Army Materiel Command, ATTN: AMCSU-TS, Department of the Army, Washington, D.C. 20315.

By Order of the Secretary of the Army:

Official:

KENNETH G. WICKHAM,
*Major General, United States Army,
The Adjutant General.*

HAROLD K. JOHNSON,
*General, United States Army,
Chief of Staff.*

Distribution:

Active Army, NG, and USAR: To be distributed in accordance with DA Form 12-9 requirements for Military Personnel, General—A.



0001158120

